

# TC72/TC77

Touch Computer



**ZEBRA**

## **Product Reference Guide** For Android 11™

ZEBRA and the stylized Zebra head are trademarks of Zebra Technologies Corporation, registered in many jurisdictions worldwide. Google, Android, Google Play and other marks are trademarks of Google LLC. All other trademarks are the property of their respective owners. ©2022 Zebra Technologies Corporation and/or its affiliates. All rights reserved.

Information in this document is subject to change without notice. The software described in this document is furnished under a license agreement or nondisclosure agreement. The software may be used or copied only in accordance with the terms of those agreements.

For further information regarding legal and proprietary statements, please go to:

SOFTWARE: [zebra.com/linkoslegal](https://zebra.com/linkoslegal).

COPYRIGHTS: [zebra.com/copyright](https://zebra.com/copyright).

WARRANTY: [zebra.com/warranty](https://zebra.com/warranty).

END USER LICENSE AGREEMENT: [zebra.com/eula](https://zebra.com/eula).

## Terms of Use

### Proprietary Statement

This manual contains proprietary information of Zebra Technologies Corporation and its subsidiaries (“Zebra Technologies”). It is intended solely for the information and use of parties operating and maintaining the equipment described herein. Such proprietary information may not be used, reproduced, or disclosed to any other parties for any other purpose without the express, written permission of Zebra Technologies.

### Product Improvements

Continuous improvement of products is a policy of Zebra Technologies. All specifications and designs are subject to change without notice.

### Liability Disclaimer

Zebra Technologies takes steps to ensure that its published Engineering specifications and manuals are correct; however, errors do occur. Zebra Technologies reserves the right to correct any such errors and disclaims liability resulting therefrom.

### Limitation of Liability

In no event shall Zebra Technologies or anyone else involved in the creation, production, or delivery of the accompanying product (including hardware and software) be liable for any damages whatsoever (including, without limitation, consequential damages including loss of business profits, business interruption, or loss of business information) arising out of the use of, the results of use of, or inability to use such product, even if Zebra Technologies has been advised of the possibility of such damages. Some jurisdictions do not allow the exclusion or limitation of incidental or consequential damages, so the above limitation or exclusion may not apply to you.

# Contents

<b>About This Guide.....</b>	<b>14</b>
Configurations.....	14
Notational Conventions.....	14
Icon Conventions.....	15
Service Information.....	15
Determining Software Versions.....	15
Determining the Serial Number.....	16
<b>Getting Started.....</b>	<b>17</b>
Unpacking the Device.....	17
Device Features.....	18
Setting Up the Device.....	20
Removing the SIM Lock Access Cover.....	20
Installing the SIM Card.....	21
Installing the SAM Card.....	24
Installing a microSD Card.....	25
Installing the Hand Strap and Battery.....	28
Installing the Battery.....	30
Device Charging.....	30
Charging the Battery.....	30
Charging Indicators.....	31
Replacing the Battery.....	31
Replacing the SIM or SAM Card.....	33
Replacing the microSD Card.....	35

<b>Using the Device.....</b>	<b>39</b>
Home Screen.....	39
Setting Home Screen Rotation.....	40
Status Bar.....	40
Managing Notifications.....	44
Opening the Quick Access Panel.....	45
Editing Icons on the Quick Settings Bar.....	46
Battery Management.....	47
Checking Battery Status.....	47
Monitoring Battery Usage.....	47
Low Battery Notification.....	48
Interactive Sensor Technology.....	48
Waking the Device.....	48
USB Communication.....	49
Transferring Files.....	49
Transferring Photos.....	49
Disconnecting from the Host Computer.....	49
<b>Settings.....</b>	<b>51</b>
Accessing Settings.....	51
Display Settings.....	51
Setting the Screen Brightness Manually.....	51
Setting the Screen Brightness Automatically.....	51
Setting Night Light.....	52
Setting Screen Rotation.....	52
Setting Screen Timeout.....	52
Setting Lock Screen Notifications.....	52
Setting Touch Key Light.....	53
Setting Font Size.....	53
Notification LED Brightness Level.....	53
Setting Touch Panel Mode.....	54
Setting the Date and Time.....	54
General Sound Setting.....	55
Sound Options.....	55

Zebra Volume Controls.....	55
Setting Wake-Up Sources.....	56
Remapping a Button.....	56
Keyboards.....	56
Keyboard Configuration.....	56
Using the Android and Gboard Keyboards.....	57
Enterprise Keyboard.....	58
Language Usage.....	58
Changing the Language Setting.....	58
Adding Words to the Dictionary.....	59
Notifications.....	59
Setting App Notifications.....	59
Viewing Notifications.....	60
Controlling Lock Screen Notifications.....	60
Enabling Blink Light.....	60
<b>Applications.....</b>	<b>62</b>
Installed Applications.....	62
Accessing Apps.....	63
Switching Between Recent Apps.....	63
Battery Manager.....	64
Opening Battery Manager.....	64
Battery Manager Information Tab.....	64
Battery Manager Swap Tab.....	66
Camera.....	66
Taking Photos.....	67
Taking a Panoramic Photo.....	68
Recording Videos.....	69
Photo Settings.....	70
Video Settings.....	72
DataWedge Demonstration.....	74
DataWedge Demonstration Icons.....	74
Selecting a Scanner.....	74
PTT Express Voice Client.....	75

PTT Express User Interface.....	75
PTT Audible Indicators.....	76
PTT Notification Icons.....	76
Enabling PTT Communication.....	77
Selecting a Talk Group.....	77
PTT Communication.....	77
Disabling PTT Communication.....	78
RxLogger.....	78
RxLogger Configuration.....	78
Configuration File.....	78
Enabling Logging.....	78
Disabling Logging.....	79
Extracting Log Files.....	79
Backing Up Data.....	79
RxLogger Utility.....	79
<b>Data Capture.....</b>	<b>81</b>
Imaging.....	81
Digital Camera.....	81
Linear Imager.....	82
Operational Modes.....	82
Scanning Considerations.....	83
Scanning with Internal Imager.....	83
Scanning with Internal Camera.....	86
Scanning with the RS507/RS507X Hands-Free Imager.....	87
Scanning with the RS5100 Ring Scanner.....	90
Scanning with the RS6000 Bluetooth Ring Scanner.....	91
Scanning with the DS2278 Digital Scanner.....	94
Scanning with the DS3578 Bluetooth Scanner.....	95
Scanning with the DS3608 USB Scanner.....	97
Scanning with the DS8178 Digital Scanner.....	99
Scanning with the LI3678 Linear Imager.....	100
Scanning with the DS3678 Bluetooth Scanner.....	102
Pairing a Bluetooth Ring Scanner.....	103

Pairing in SSI Mode Using Near Field Communication.....	103
Pairing Using Simple Serial Interface (SSI).....	104
Pairing Using Bluetooth Human Interface Device.....	104
Pairing a Bluetooth Scanner.....	105
Pairing Using Simple Serial Interface.....	105
Pairing Using Bluetooth Human Interface Device.....	106
DataWedge.....	107
Enabling DataWedge.....	107
Disabling DataWedge.....	107
Supported Devices.....	108
Camera Supported Decoders.....	108
SE4750-SR and SE4750-MR Internal Imager Supported Decoders.....	108
SE4770 Internal Imager Supported Decoders.....	109
RS507/RS507x Supported Decoders.....	110
RS5100 Supported Decoders.....	111
RS6000 Supported Decoders.....	112
DS2278 Supported Decoders.....	112
DS3578 Supported Decoders.....	113
DS3608 Supported Decoders.....	114
DS3678 Supported Decoders.....	115
DS8178 Supported Decoders.....	116
LI3678 Supported Decoders.....	116
<b>Wireless.....</b>	<b>118</b>
Wireless Wide Area Networks.....	118
Sharing the Mobile Data Connection.....	118
Data Usage.....	120
Cellular Network Settings.....	121
Wireless Local Area Networks.....	123
Connecting to a Wi-Fi Network.....	124
Wi-Fi Version.....	124
Removing a Wi-Fi Network.....	124
WLAN Configuration.....	124
Configuring a Secure Wi-Fi Network.....	125

Manually Adding a Wi-Fi Network.....	126
Configuring for a Proxy Server.....	127
Configuring the Device to Use a Static IP Address.....	127
Wi-Fi Preferences.....	128
Additional Wi-Fi Settings.....	128
Wi-Fi Direct.....	129
Bluetooth.....	129
Adaptive Frequency Hopping.....	130
Security.....	130
Bluetooth Profiles.....	131
Bluetooth Power States.....	132
Bluetooth Radio Power.....	132
Discovering Bluetooth Device(s).....	132
Changing the Bluetooth Name.....	133
Connecting to a Bluetooth Device.....	133
Selecting Profiles on the Bluetooth Device.....	133
Unpairing a Bluetooth Device.....	133
Using a Bluetooth Headset.....	133
Cast.....	134
Near Field Communications.....	134
Reading NFC Cards.....	134
Sharing Information Using NFC.....	135
Enterprise NFC Settings.....	136
<b>Calls.....</b>	<b>137</b>
Emergency Calling.....	137
Audio Modes.....	137
Bluetooth Headset.....	137
Wired Headset.....	138
Adjusting Audio Volume.....	138
Making a Call Using the Dialer.....	138
Accessing Dialing Options.....	139
Make a Call Using Contacts.....	139
Using the Dialer.....	139



Using the Contacts App.....	140
Make a Call Using Call History.....	140
Using the Call History List.....	140
Making a Conference Call on GSM.....	140
Making a Call Using a Bluetooth Headset.....	141
Answering Calls.....	141
Call Settings.....	142
<b>Accessories.....</b>	<b>145</b>
Battery Charging.....	148
Main Battery Charging.....	148
Spare Battery Charging.....	148
Charging Temperature.....	148
2-Slot Charge Only Cradle.....	148
2-Slot Charge Only Cradle Setup.....	149
Charging the Device with the 2-Slot Charge Only Cradle.....	150
Charging the Spare Battery with the 2-Slot Charge Only Cradle.....	150
2-Slot USB-Ethernet Cradle.....	151
2-Slot USB-Ethernet Cradle Setup.....	152
Charging the Device with the 2-Slot USB-Ethernet Cradle.....	153
Charging the Spare Battery with the 2-Slot USB-Ethernet Cradle.....	154
USB and Ethernet Communication.....	154
5-Slot Charge Only Cradle.....	156
5-Slot Charge Only Cradle Setup.....	157
Charging the Device with the 5-Slot Charge Only Cradle.....	158
Installing the Four Slot Battery Charger.....	159
Removing the Four Slot Battery Charger.....	164
4-Slot Charge Only Cradle with Battery Charger.....	164
4-Slot Charge Only Cradle with Battery Charger Setup.....	166
Charging the Device with a 4-Slot Charge Only Cradle with Battery Charger.....	167
Charging the Batteries with a 4-Slot Charge Only Cradle with Battery Charger.....	167
5-Slot Ethernet Cradle.....	168
5-Slot Ethernet Cradle Setup.....	169
Daisy-chaining Ethernet Cradles.....	170

Charging the Device with a 5-Slot Ethernet Cradle.....	171
Installing the Four Slot Battery Charger.....	172
Removing the Four Slot Battery Charger.....	177
Ethernet Communication.....	177
4-Slot Battery Charger.....	179
4-Slot Battery Charger Setup.....	180
Charging Spare Batteries in the 4-Slot Battery Charger.....	181
3.5 mm Audio Adapter.....	181
Connecting a Headset to the 3.5 mm Audio Adapter.....	182
Attaching the 3.5 mm Audio Adapter.....	183
Device with 3.5 mm Audio Adapter in Holster.....	183
Removing the 3.5 mm Audio Adapter.....	183
Snap-On USB Cable.....	184
Attaching the Snap-On USB Cable.....	184
Connecting the Snap-On USB Cable to a Computer.....	185
Charging the Device with the Snap-On USB Cable.....	185
Removing the Snap-On USB Cable from the Device.....	186
Charging Cable Cup.....	187
Charging the Device with the Charging Cable Cup.....	187
Snap-On DEX Cable.....	189
Attaching the Snap-On DEX Cable.....	189
Connecting the Snap-On DEX Cable.....	189
Disconnecting the Snap-On DEX Cable from the Device.....	190
Trigger Handle.....	191
Installing the Attachment Plate to Trigger Handle.....	191
Installing the Trigger Handle Plate.....	192
Inserting the Device into the Trigger Handle.....	193
Removing the Device from the Trigger Handle.....	194
Vehicle Charging Cable Cup.....	196
Charging the Device with the Vehicle Charging Cable.....	197
Vehicle Cradle.....	198
Inserting the Device into the Vehicle Cradle.....	200
Removing the Device from the Vehicle Cradle.....	201
Charging the Device in the Vehicle Cradle.....	201

TC7X Vehicle Communication Charging Cradle.....	201
Inserting the Device into the TC7X Vehicle Communication Charging Cradle.....	202
Removing the Device from the TC7X Vehicle Communication Charging Cradle.....	203
Charging the Device in the TC7X Vehicle Communication Charging Cradle.....	203
USB IO Hub.....	203
Connecting Cables to the USB IO Hub.....	204
Connecting External Cable to the USB IO Hub.....	205
Powering the Vehicle Cradle.....	206
Audio Headset Connection.....	207
Replacing the Hand Strap.....	208
<b>Application Deployment.....</b>	<b>212</b>
Android Security.....	212
Secure Certificates.....	212
Installing a Secure Certificate.....	212
Configuring Credential Storage Settings.....	213
Android Development Tools.....	213
Android Development Workstation.....	213
Enabling Developer Options.....	213
EMDK for Android.....	214
StageNow for Android.....	214
GMS Restricted.....	214
ADB USB Setup.....	215
Enabling USB Debugging.....	215
Entering Android Recovery Manually.....	216
Application Installation Methods.....	216
Installing Applications Using the USB Connection.....	216
Installing Applications Using the Android Debug Bridge.....	217
Installing Applications Using Wireless ADB.....	217
Installing Applications Using a microSD Card.....	219
Uninstalling an Application.....	219
Android System Update.....	220
Performing a System Update Using microSD Card.....	220
Performing a System Update Using ADB.....	220

Performing a System Update Using Wireless ADB.....	221
Verifying System Update Installation.....	223
Android Enterprise Reset.....	223
Performing an Enterprise Reset From Device Settings.....	223
Performing an Enterprise Reset Using microSD Card.....	223
Performing an Enterprise Reset Using Wireless ADB.....	224
Performing an Enterprise Reset Using ADB.....	225
Android Factory Reset.....	226
Performing a Factory Reset Using microSD Card.....	227
Performing a Factory Reset Using ADB.....	227
Performing a Factory Rest Using Wireless ADB.....	228
Android Storage.....	230
Random Access Memory.....	230
Internal Storage.....	231
External Storage.....	231
Enterprise Folder.....	232
Managing Apps.....	232
App Details.....	232
Managing Downloads.....	233
<b>Maintenance and Troubleshooting.....</b>	<b>234</b>
Maintaining the Device.....	234
Battery Safety Guidelines.....	234
Best Practices for Enterprise Mobile Computing Devices Operating in Hot Environments and Direct Sunlight.....	235
Cleaning Instructions.....	235
Approved Cleanser Active Ingredients.....	236
Harmful Ingredients.....	236
Device Cleaning Instructions.....	236
Special Cleaning Notes.....	236
Cleaning Materials Required.....	237
Cleaning Frequency.....	237
Cleaning the Device.....	237
Housing.....	237

Display.....	237
Camera and Exit Window.....	237
Cleaning Battery Connectors.....	237
Cleaning Cradle Connectors.....	238
Troubleshooting.....	238
Troubleshooting the Device.....	238
Troubleshooting the 2-Slot Charge Only Cradle.....	241
Troubleshooting the 2-Slot USB/Ethernet Cradle.....	241
Troubleshooting the 5-Slot Charge Only Cradle.....	242
Troubleshooting the 5-Slot Ethernet Cradle.....	243
Troubleshooting the 4-Slot Battery Charger.....	243
<b>Technical Specifications.....</b>	<b>245</b>
Data Capture Supported Symbologies.....	245
SE4750-SR Decode Distances.....	245
SE4750-MR Decode Distances.....	246
SE4770 Decode Distances.....	246
I/O Connector Pin-Outs.....	247
2-Slot Charge Only Cradle Technical Specifications.....	247
2-Slot USB/Ethernet Cradle Technical Specifications.....	248
5-Slot Charge Only Cradle Technical Specifications.....	248
5-Slot Ethernet Cradle Technical Specifications.....	249
4-Slot Battery Charger Technical Specifications.....	249
Charge Only Vehicle Cradle Technical Specifications.....	250
Trigger Handle Technical Specifications.....	250
Charging Cable Cup Technical Specifications.....	250
Snap-On USB Cable Technical Specifications.....	251
DEX Cable Technical Specifications.....	251

# About This Guide

## Configurations

This guide covers the following device configurations.

Configuration	Radios	Display	Memory	Data Capture Options	Operating System
TC720L	WLAN: 802.11 a/b/g/n/ ac/d/h/i/r/k/v3/wWPAN: Bluetooth v5.0 Low Energy	4.7" High Definition (1280 x 720) LCD	4 GB RAM/32 GB Flash	2D imager, camera and integrated NFC	Androidbased, Google ™ Mobile Services (GMS) 11
TC77HL	WWAN: HSPA+/LTE/ CDMAWLAN: 802.11 a/b/g/ n/ac/d/h/i/r/k/v3/wWPAN: Bluetooth v5.0 Low Energy	4.7" High Definition (1280 x 720) LCD	4 GB RAM/32 GB Flash	2D imager, camera and integrated NFC	Androidbased, Google ™ Mobile Services (GMS) 11

## Notational Conventions

The following conventions are used in this document:

- **Bold** text is used to highlight the following:
  - Dialog box, window, and screen names
  - Drop-down list and list box names
  - Checkbox and radio button names
  - Icons on a screen
  - Key names on a keypad
  - Button names on a screen
- Bullets (•) indicate:
  - Action items
  - List of alternatives
  - Lists of required steps that are not necessarily sequential.
- Sequential lists (for example, those that describe step-by-step procedures) appear as numbered lists.

### Icon Conventions

The documentation set is designed to give the reader more visual clues. The following visual indicators are used throughout the documentation set.



**NOTE:** The text here indicates information that is supplemental for the user to know and that is not required to complete a task.



**IMPORTANT:** The text here indicates information that is important for the user to know.



**CAUTION:** If the precaution is not heeded, the user could receive a minor or moderate injury.



**WARNING:** If danger is not avoided, the user CAN be seriously injured or killed.



**DANGER:** If danger is not avoided, the user WILL be seriously injured or killed.

### Service Information

If you have a problem with your equipment, contact Zebra Global Customer Support for your region. Contact information is available at: [zebra.com/support](https://zebra.com/support).

When contacting support, please have the following information available:

- Serial number of the unit
- Model number or product name
- Software type and version number


Zebra responds to calls by email, telephone, or fax within the time limits set forth in support agreements.

If your problem cannot be solved by Zebra Customer Support, you may need to return your equipment for servicing and will be given specific directions. Zebra is not responsible for any damages incurred during shipment if the approved shipping container is not used. Shipping the units improperly can possibly void the warranty.

If you purchased your Zebra business product from a Zebra business partner, contact that business partner for support.

### Determining Software Versions

Before contacting Customer Support, determine the current software version on your device.

1. Swipe down from the Status bar with two fingers to open the Quick Access panel, and then touch .
2. Touch **About phone**.

**3.** Scroll to view the following information:


- Battery information
- Emergency information
- SW components
- Legal information
- Model & hardware
- Android version
  - Android Security Update
  - Google Play system update
  - Baseband version
  - Kernel version
  - Build number

To determine the device International Mobile Equipment Identity (IMEI) information (WWAN only), touch **About phone > IMEI**.

- **IMEI** - Displays the IMEI number for the device.
- **IMEI SV** - Displays the IMEI software version (SV) number for the device.

## Determining the Serial Number

Before contacting Customer Support, determine the serial number of your device.

- 1.** Swipe down from the Status bar with two fingers to open the Quick Access panel, and then touch .
- 2.** Touch **About phone**.
- 3.** Touch **Model & hardware**.
- 4.** Touch **Serial number**.



# Getting Started

This chapter provides information to get the device up and running for the first time.

## Unpacking the Device

1. Carefully remove all protective material from the device and save the shipping container for later storage and shipping.
2. Verify that the following are included:
  - Touch computer
  - 4,620 mAh PowerPrecision+ Lithium-ion battery
  - Hand strap
  - Regulatory Guide.
3. Inspect the equipment for damage. If any equipment is missing or damaged, contact the Global Customer Support center immediately.
4. Prior to using the device for the first time, remove the protective shipping film that covers the scan window, display, and camera window.

## Device Features

Figure 1 Front View

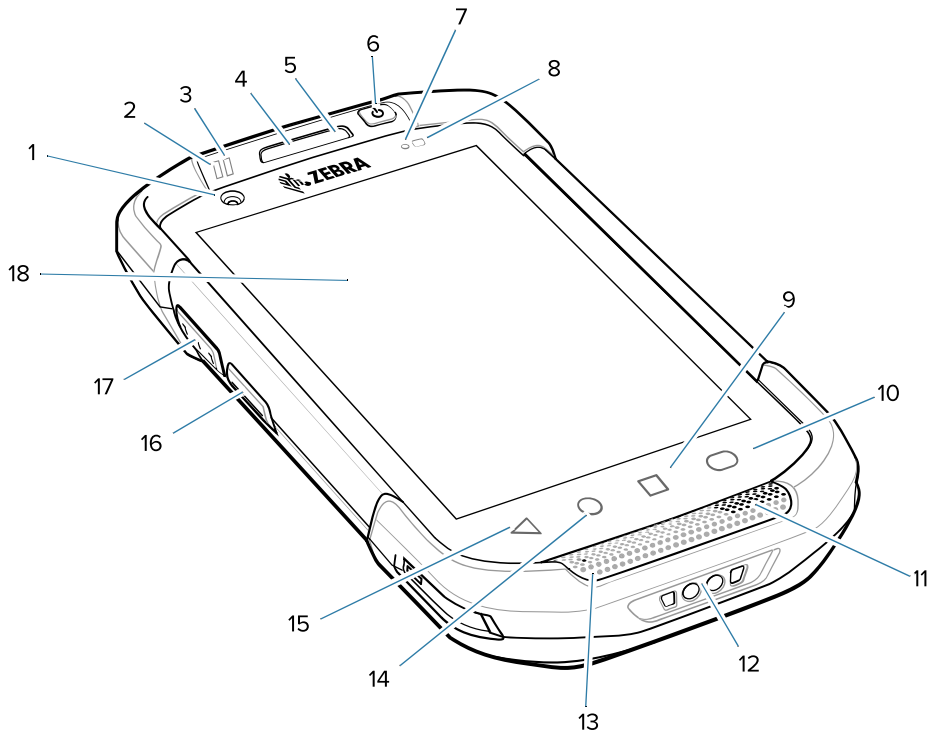


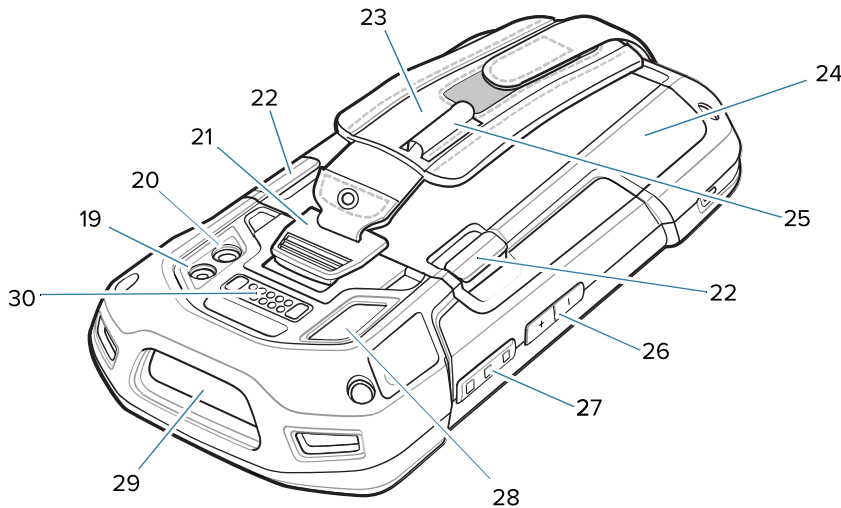
Table 1 Front View Features

Number	Item	Function
1	Front facing camera	Use to take photos and videos (optional).
2	Data capture LED	Indicates data capture status.
3	Charging/ Notification LED	Indicates battery charging status while charging and app generated notifications.
4	Receiver	Use for audio playback in Handset mode.
5	Microphone	Use for communications in Speakerphone mode.
6	Power button	Turns the display on and off. Press and hold to reset the device, power off or swap battery.
7	Proximity sensor	Determines proximity for turning off display when in handset mode.
8	Light sensor	Determines ambient light for controlling display backlight intensity.
9	Menu button	Opens a menu with items that affect the current screen or app.
10	Search button	Opens the Recent App screen.

**Table 1** Front View Features (Continued)

Number	Item	Function
11	Speaker	Provides audio output for video and music playback. Provides audio in speakerphone mode.
12	Charging contacts	Provides power to the device from cables and cradles.
13	Microphone	Use for communications in Handset mode.
14	Home button	Displays the Home screen with a single press. On device with GMS, opens the Google Now screen when held for a short period of time.
15	Back button	Displays the previous screen.
16	PTT button	Initiates push-to-talk communications (programmable).
17	Scan button	Initiates data capture (programmable).
18	Touch screen	Displays all information needed to operate the device.

**Figure 2** Rear View



**Table 2** Rear View Features

Number	Item	Function
19	Camera flash	Provides illumination for the camera.
20	Camera	Takes photos and videos.
21	Hand strap mounting point	Provides latching point for the hand strap.
22	Battery release latches	Press to remove the battery.

**Table 2** Rear View Features (Continued)

Number	Item	Function
23	Hand strap	Use to securely hold the device in your hand.
24	Battery	Provides power to the device.
25	Elastic sleeve	Use to hold optional stylus.
26	Volume up/down button	Increase and decrease audio volume (programmable).
27	Scan button	Initiates data capture (programmable).
28	Microphone	Use during video recording and for noise cancellation.
29	Exit window	Provides data capture using the imager.
30	Interface connector	Provides USB host and client communications, audio and device charging via cables and accessories.

## Setting Up the Device

To start using the device for the first time:

1. Remove the SIM Lock Access Cover (TC77 with SIM Lock only).
2. Install a SIM card (TC77 only).
3. Install a SAM card.
4. Install a micro secure digital (SD) card (optional).
5. Install hand strap (optional).
6. Install the battery.
7. Charge the device.
8. Power on the device.

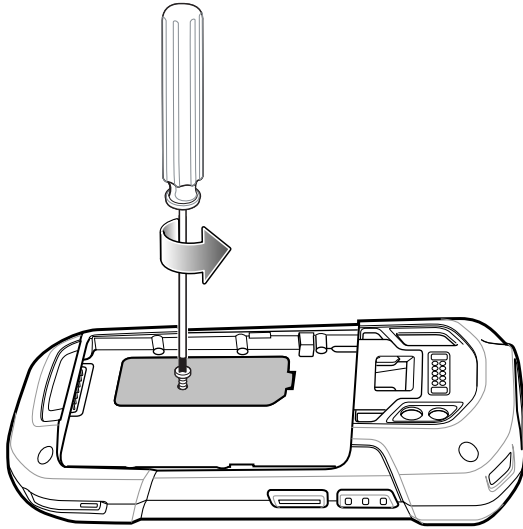
## Removing the SIM Lock Access Cover

TC77 models with the SIM Lock feature include an access door that is secured using a Microstix 3ULR-0 screw.



**NOTE:** TC77 with SIM Lock only.

1. To remove the access cover, use a Microstix TD-54(3ULR-0) screwdriver to remove the screw from the access panel.



2. After re-installing the access cover, make sure to use a Microstix TD-54(3ULR-0) screwdriver to re-install the screw.

### Installing the SIM Card



**NOTE:** TC77 only.

Only use a nano SIM card.



**CAUTION:** Follow proper electrostatic discharge (ESD) precautions to avoid damaging the SIM card. Proper ESD precautions include, but not limited to, working on an ESD mat and ensuring that the user is properly grounded.

- 1. Lift the access door.

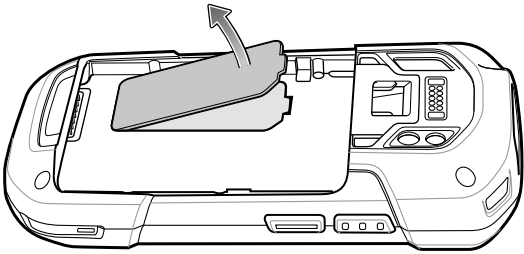
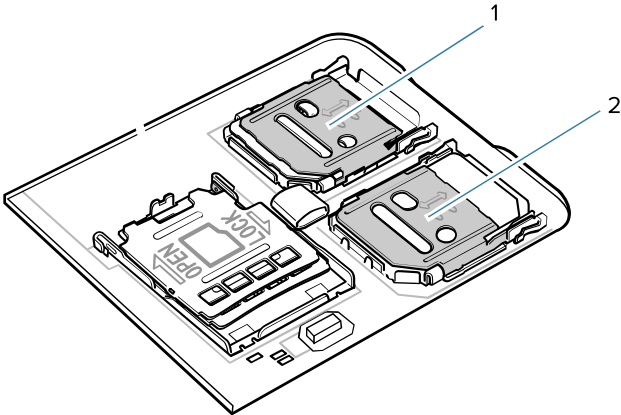
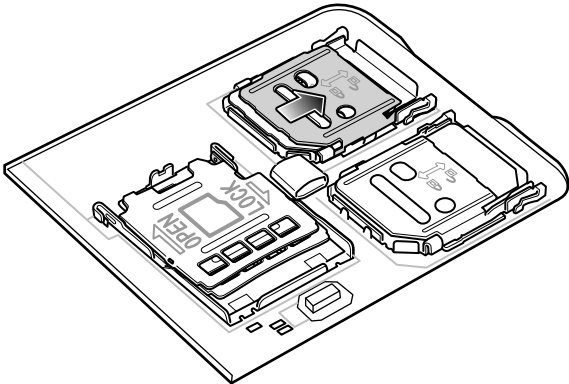


Figure 3 TC77 SIM Slot Locations

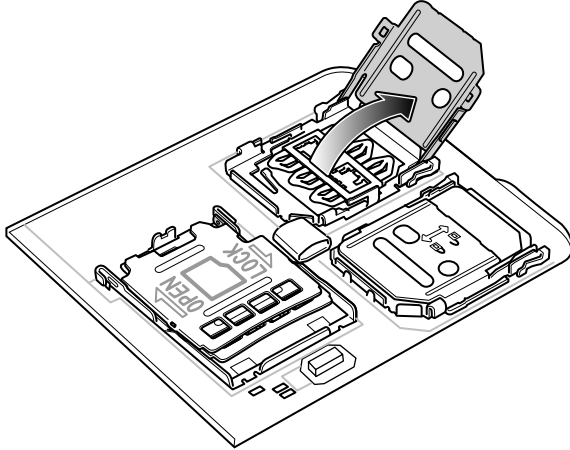


1	nano SIM Slot 1 (default)
2	nano SIM Slot 2

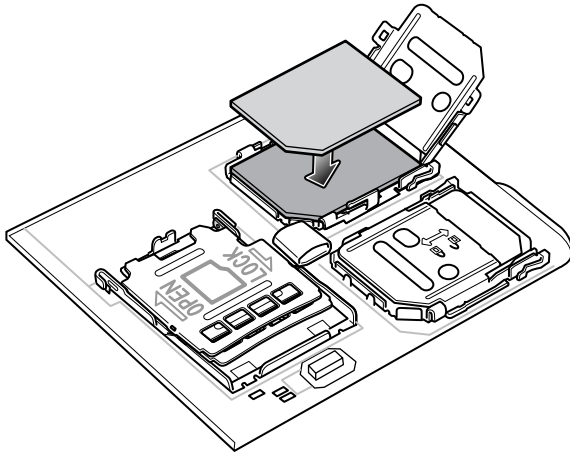
- 2. Slide the SIM card holder to the unlock position.



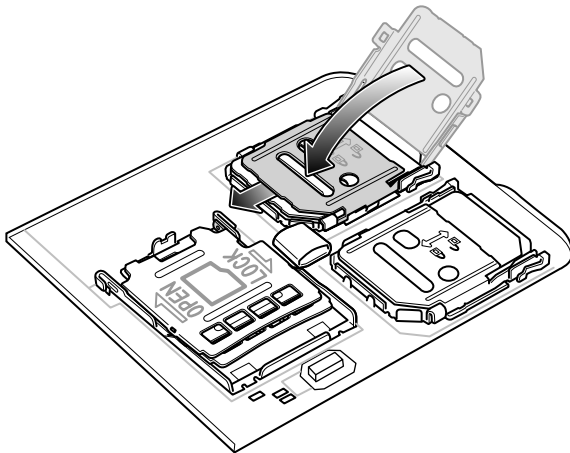
3. Lift the SIM card holder door.



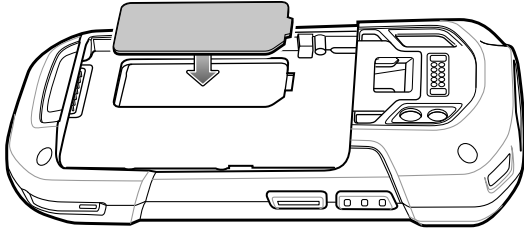
4. Place the nano SIM card into the card holder with contacts facing down.



5. Close the SIM card holder door and slide to the lock position.



6. Replace the access door.



7. Press the access door down and ensure that it is properly seated.



**CAUTION:** Access door must be replaced and securely seated to ensure proper device sealing.

## Installing the SAM Card

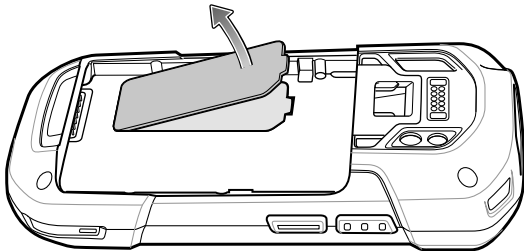


**CAUTION:** Follow proper electrostatic discharge (ESD) precautions to avoid damaging the Secure Access Module (SAM) card. Proper ESD precautions include, but not limited to, working on an ESD mat and ensuring that the user is properly grounded.

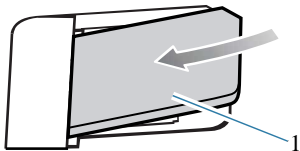


**NOTE:** If using a micro SAM card, a third-party adapter is required.

1. Lift the access door.



2. Insert a SAM card into the SAM slot with the cut edge toward the middle of the device and the contacts facing down.



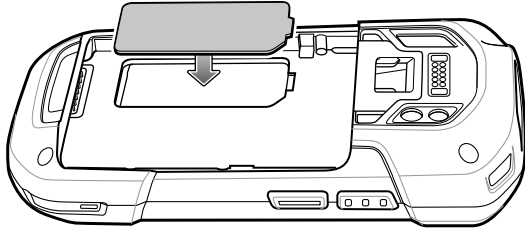
1

Mini SAM Slot

3. Ensure that the SAM card is seated properly.



4. Replace the access door.



5. Press the access door down and ensure that it is properly seated.



**CAUTION:** Access door must be replaced and securely seated to ensure proper device sealing.

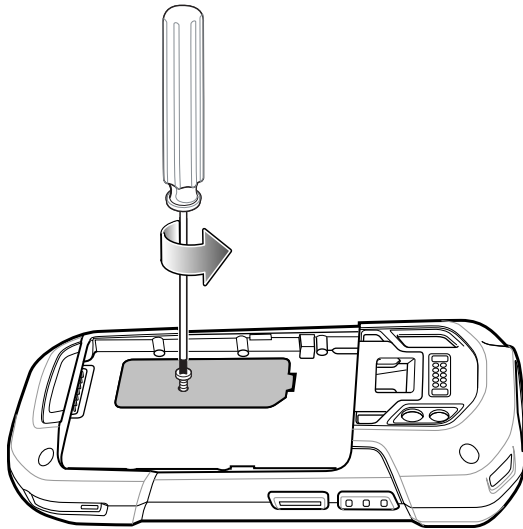
### Installing a microSD Card

The microSD card slot provides secondary non-volatile storage. The slot is located under the battery pack. Refer to the documentation provided with the card for more information, and follow the manufacturer's recommendations for use.

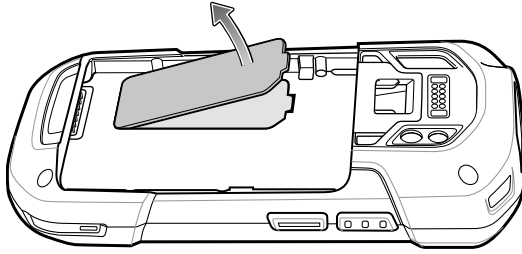


**CAUTION:** Follow proper electrostatic discharge (ESD) precautions to avoid damaging the microSD card. Proper ESD precautions include, but are not limited to, working on an ESD mat and ensuring that the operator is properly grounded.

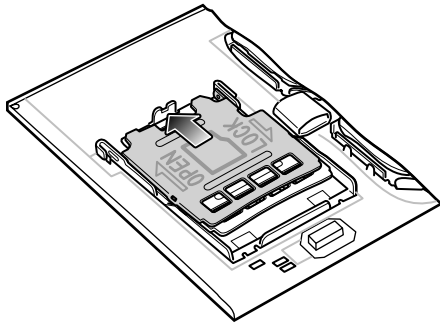
1. Remove the hand strap, if installed.
2. If the device has a secure access door, use a Microstix 0 screwdriver to remove the 3ULR-0 screw.



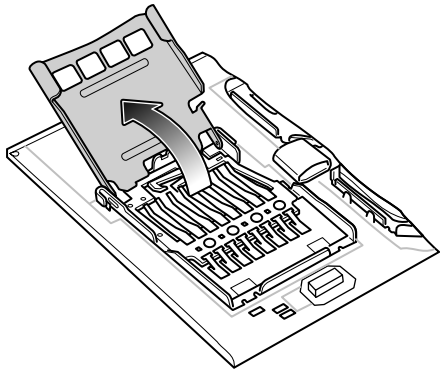
3. Lift the access door.



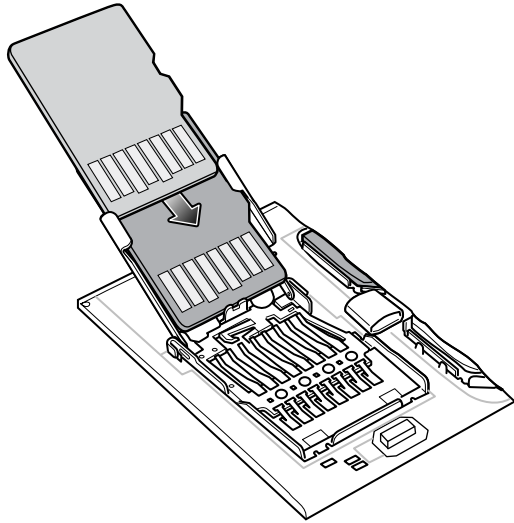
4. Slide the microSD card holder to the Open position.



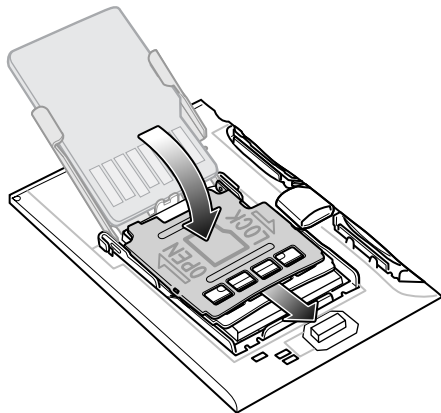
5. Lift the microSD card holder.



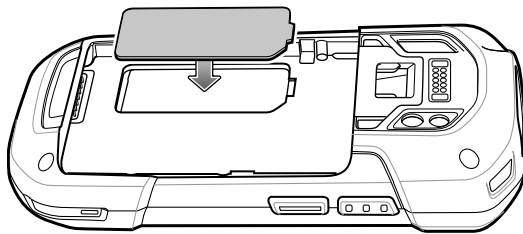
6. Insert the microSD card into the card holder door ensuring that the card slides into the holding tabs on each side of the door.



7. Close the microSD card holder door and slide the door to the Lock position.



8. Replace the access door.

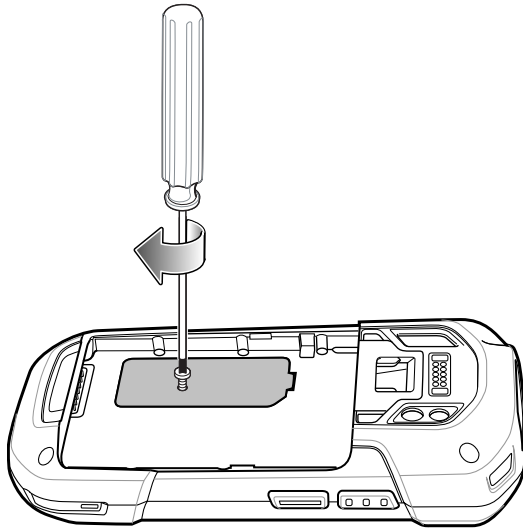


9. Press the access door down and ensure that it is properly seated.



**CAUTION:** Access door must be replaced and securely seated to ensure proper device sealing.

10. If the device has a secure access door, use a Microstix 0 screwdriver to install the 3ULR-0 screw.



### Installing the Hand Strap and Battery

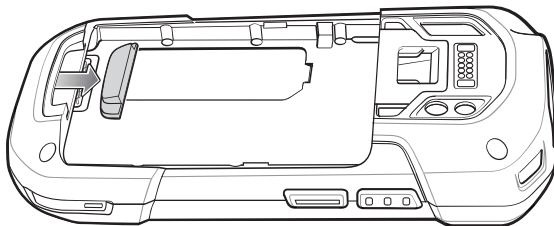


**NOTE:** User modification of the device, particularly in the battery well, such as labels, asset tags, engravings, stickers, etc., may compromise the intended performance of the device or accessories. Performance levels such as sealing (Ingress Protection (IP)), impact performance (drop and tumble), functionality, temperature resistance, etc. could be effected. DO NOT put any labels, asset tags, engravings, stickers, etc. in the battery well.

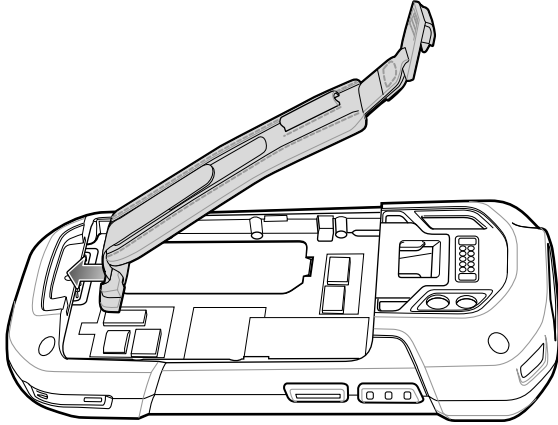


**NOTE:** Installation of the hand strap is optional. Skip this section if not installing the hand strap.

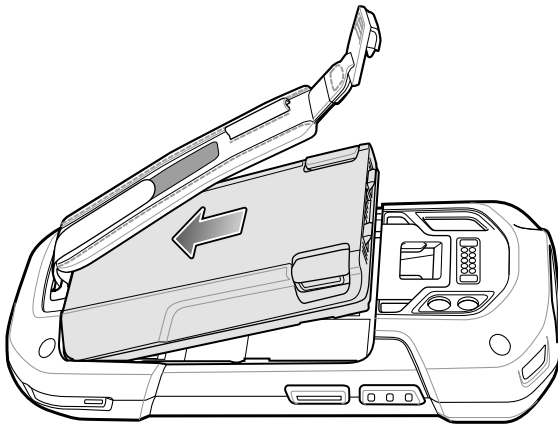
1. Remove the hand strap filler from the hand strap slot. Store the hand strap filler in a safe place for future replacement.



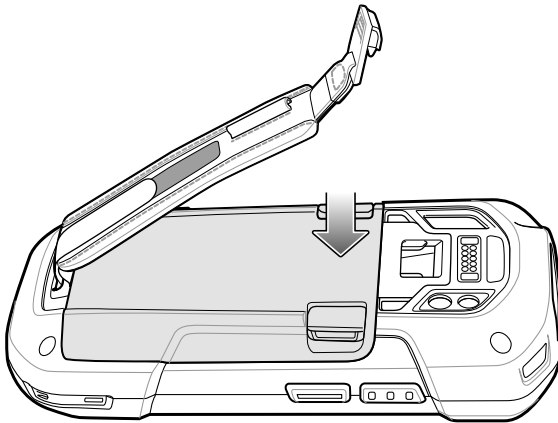
2. Insert the hand strap plate into the hand strap slot.



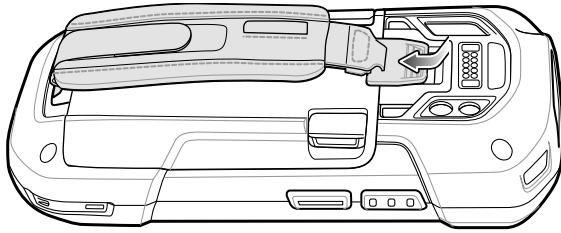
3. Insert the battery, bottom first, into the battery compartment in the back of the device.



4. Press the battery down into the battery compartment until the battery release latches snap into place.



5. Place hand strap clip into hand strap mounting slot and pull down until it snaps into place.

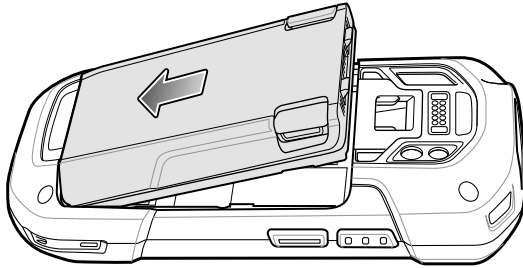


### Installing the Battery

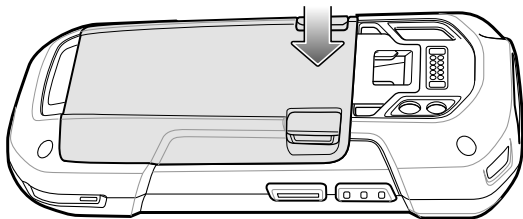


**NOTE:** User modification of the device, particularly in the battery well, such as labels, asset tags, engravings, stickers, etc., may compromise the intended performance of the device or accessories. Performance levels such as sealing (Ingress Protection (IP)), impact performance (drop and tumble), functionality, temperature resistance, etc. could be effected. **DO NOT** put any labels, asset tags, engravings, stickers, etc. in the battery well.

1. Insert the battery, bottom first, into the battery compartment in the back of the device.



2. Press the battery down into the battery compartment until the battery release latches snap into place.



### Device Charging

Before using the device for the first time, charge the main battery until the green Charging/Notification light emitting diode (LED) remains lit. To charge the device, use a cable or a cradle with the appropriate power supply. For information about the accessories available for the device, see [Accessories](#) on page 145.

The 4,620 mAh battery fully charges in less than five hours at room temperature.

### Charging the Battery

1. Connect the charging accessory to the appropriate power source.

2. Insert the device into a cradle or attach to a cable.

The device turns on and begins charging. The Charging/Notification LED blinks amber while charging, then turns solid green when fully charged.

## Charging Indicators

State	Indication
Off	The device is not charging. The device is not inserted correctly in the cradle or connected to a power source. Charger/cradle is not powered.
Slow Blinking Amber (1 blink every 4 seconds)	The device is charging.
Solid Green	Charging complete.
Fast Blinking Amber (2 blinks/second)	Charging error: <ul style="list-style-type: none"> <li>• Temperature is too low or too high.</li> <li>• Charging has gone on too long without completion (typically eight hours).</li> </ul>
Slow Blinking Red (1 blink every 4 seconds)	The device is charging but the battery is at end of useful life.
Solid Red	Charging complete but the battery is at end of useful life.
Fast Blinking Red (2 blinks/second)	Charging error but the battery is at end of useful life. <ul style="list-style-type: none"> <li>• Temperature is too low or too high.</li> <li>• Charging has gone on too long without completion (typically eight hours).</li> </ul>

## Replacing the Battery



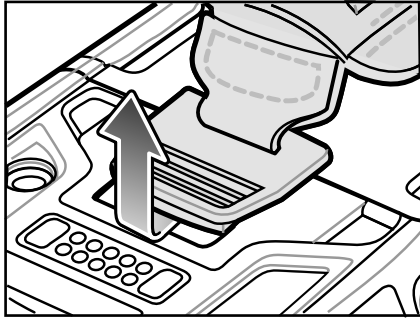
**NOTE:** User modification of the device, particularly in the battery well, such as labels, asset tags, engravings, stickers, etc., may compromise the intended performance of the device or accessories. Performance levels such as sealing (Ingress Protection (IP)), impact performance (drop and tumble), functionality, temperature resistance, etc. could be effected. DO NOT put any labels, asset tags, engravings, stickers, etc. in the battery well.



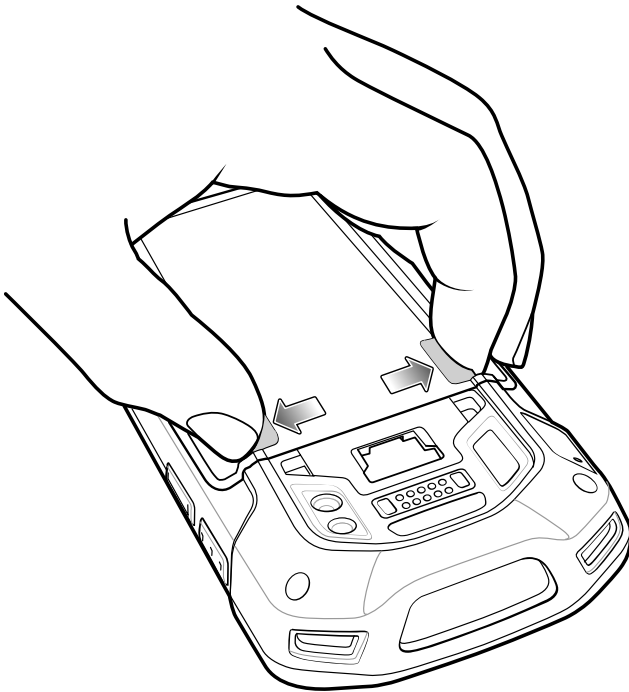
**CAUTION:** Do not add or remove SIM, SAM or microSD card during battery replacement.

1. Remove any accessory attached to the device.
2. Press the Power button until the menu appears.
3. Touch **Battery Swap**.
4. Follow the on-screen instructions.
5. Wait for the LED to turn off.

6. If hand strap is attached, slide the hand strap clip up toward the top of the device and then lift.

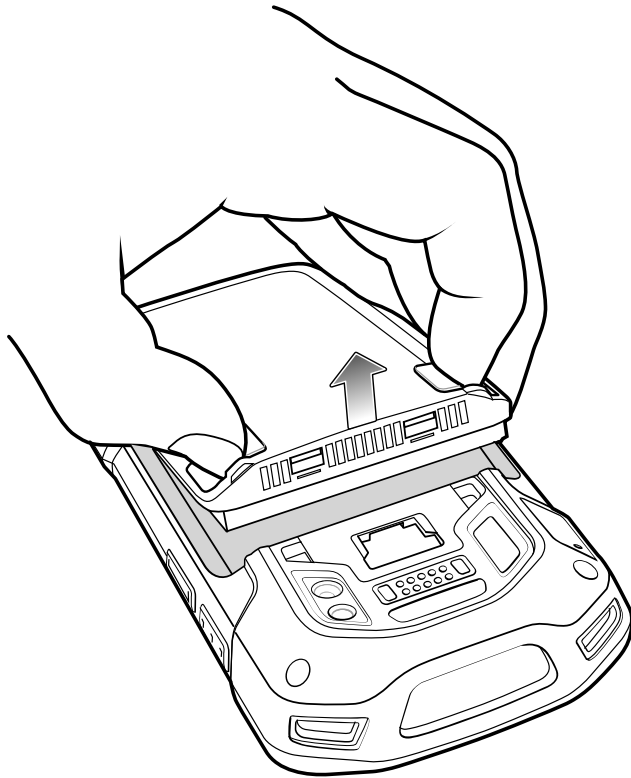


7. Press the two battery latches in.





8. Lift the battery from the device.



**CAUTION:** Replace the battery within two minutes. After two minutes the device reboots and data may be lost.

9. Insert the replacement battery, bottom first, into the battery compartment in the back of the device.
10. Press the battery down until the battery release latch snaps into place.
11. Replace the hand strap, if required.
12. Press and hold the Power button to turn on the device.



**NOTE:** After replacing the battery, wait 15 minutes before using Battery Swap again.

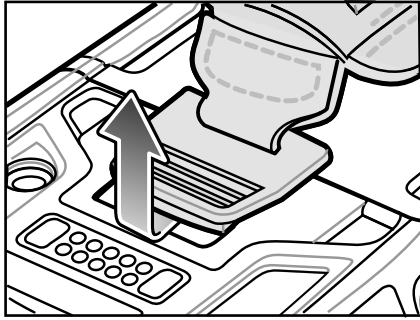
## Replacing the SIM or SAM Card



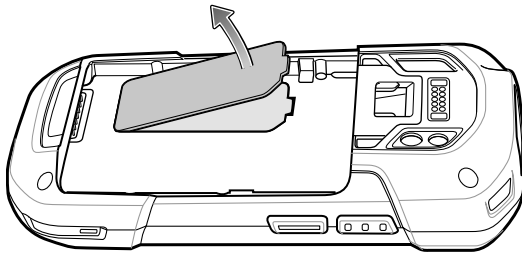
**NOTE:** SIM replacement applies to TC77 only.

1. Press and hold the Power button until the menu appears.
2. Touch **Power off**.
3. Touch **OK**.

4. If hand strap is attached, slide the hand strap clip up toward the top of the device and then lift.

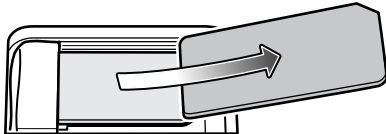


5. Press the two battery latches in.
6. Lift the battery from the device.
7. Lift the access door.

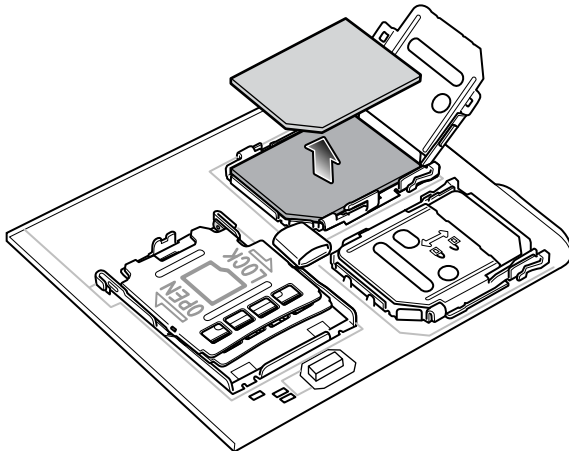


8. Remove card from holder.

**Figure 4** Remove SAM Card

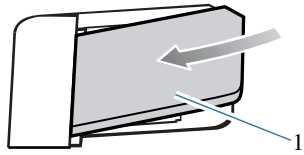


**Figure 5** Remove Nano SIM Card



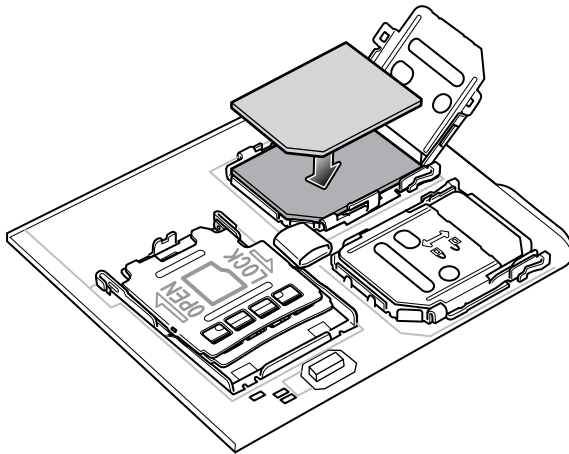
9. Insert the replacement card.

**Figure 6** Insert SAM Card

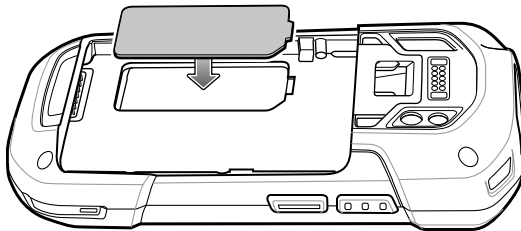


1	Mini SAM Slot
---	---------------

**Figure 7** Insert Nano SIM Card



10. Replace the access door.



11. Press the access door down and ensure that it is properly seated.



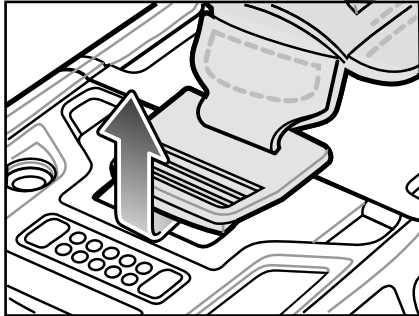
**CAUTION:** Access door must be replaced and securely seated to ensure proper device sealing.

12. Insert the battery, bottom first, into the battery compartment in the back of the device.
13. Press the battery down until the battery release latch snaps into place.
14. Replace the hand strap, if required.
15. Press and hold the Power button to turn on the device.

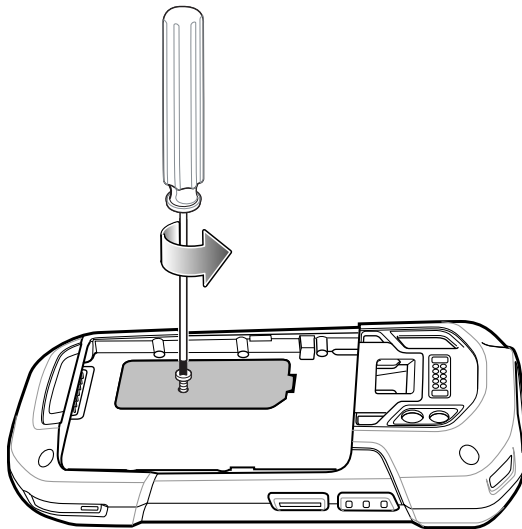
## Replacing the microSD Card

1. Press the Power button until the menu appears.

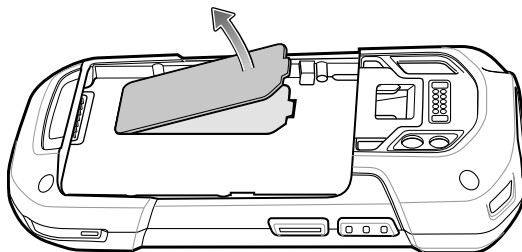
2. Touch **Power off**.
3. Touch **OK**.
4. If hand strap is attached, slide the hand strap clip up toward the top of the device and then lift.



5. Press the two battery latches in.
6. Lift the battery from the device.
7. If the device has a secure access door, use a Microstix 0 screwdriver to remove the 3ULR-0 screw.

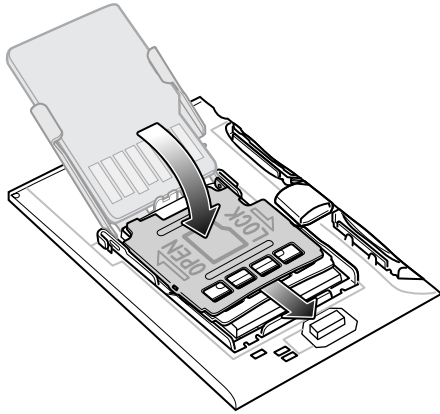


8. Lift the access door.

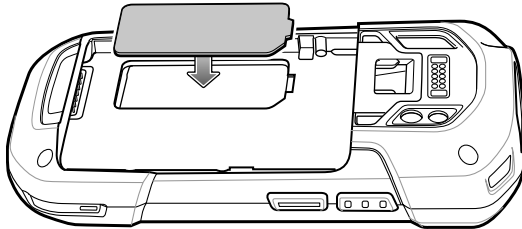


9. Slide the microSD card holder to the Open position.
10. Lift the microSD card holder.
11. Remove microSD card from holder.

12. Insert the replacement microSD card into the card holder door ensuring that the card slides into the holding tabs on each side of the door.
13. Close the microSD card holder door and slide the door to the Lock position.



14. Replace the access door.

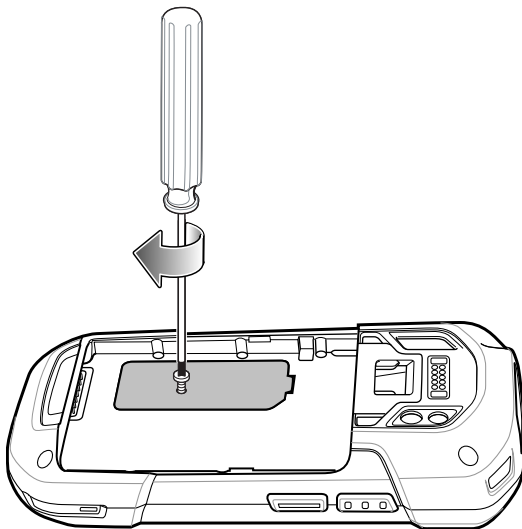


15. Press the access door down and ensure that it is properly seated.



**CAUTION:** Access door must be replaced and securely seated to ensure proper device sealing.

16. If the device has a secure access door, use a Microstix 0 screwdriver to install the 3ULR-0 screw.



17. Insert the battery, bottom first, into the battery compartment in the back of the device.
18. Press the battery down until the battery release latch snaps into place.

- 19.** Replace the hand strap, if required.
- 20.** Press and hold the Power button to turn on the device.

# Using the Device

This section explains how to use your device.

## Home Screen

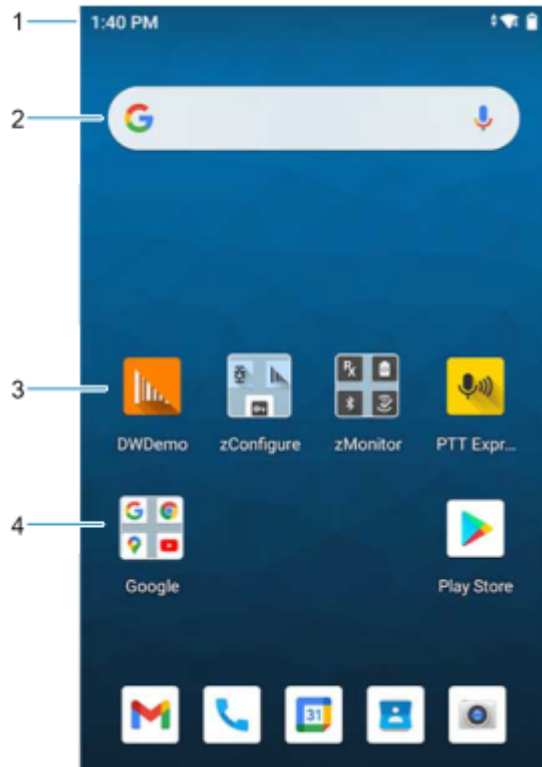
Turn on the device to display the Home screen. Depending on how your system administrator configured your device, your Home screen may appear differently than the graphics in this section.

After the device goes into Sleep mode, the Home screen displays with the lock slider. Touch the screen and slide up to unlock. The Home screen provides four additional screens to place widgets and shortcuts. Swipe the screen left or right to view the additional screens.



**NOTE:** By default, AOSP devices do not have the same icons on the Home screen as GMS devices. Icons are shown below for example only.

Home screen icons can be configured by the user and may look different than shown.



1	Status Bar	Displays the time, status icons (right side), and notification icons (left side).
2	Widgets	Launches stand-alone apps that run on the Home screen.
3	Shortcut Icon	Opens apps installed on the device.
4	Folder	Contains apps.

## Setting Home Screen Rotation

By default, the Home screen rotation is disabled.

1. Touch and hold anywhere on the Home screen until the options appear.
2. Touch **Home settings**.
3. Touch the **Allow Home screen rotation** switch.
4. Touch **Home**.
5. Rotate the device.

## Status Bar

The Status bar displays the time, notification icons (left side), and status icons (right side).

If there are more notifications than can fit in the Status bar, a dot displays indicating that more notifications exist. Swipe down from the Status bar to open the Notification panel and view all notifications and status.

**Figure 8** Notifications and Status Icons



1	Notification icons
2	Status icons

## Notification Icons


















Notification icons indicate app events and messages.

**Table 3** Notification Icons





Icon	Description
	Main battery is low.
	More notifications are available for viewing.



**Table 3** Notification Icons (Continued)

Icon	Description
	Data is syncing.
	Indicates an upcoming event. AOSP devices only.
	Indicates an upcoming event. GMS devices only.
	Open Wi-Fi network is available.
	Audio is playing.
	Problem with sign-in or sync has occurred.
	Device is uploading data.
	Animated: the device is downloading data. Static: the download is complete.
	Device is connected to or disconnected from a virtual private network (VPN).
	Preparing internal storage by checking it for errors.
	USB debugging is enabled on the device.
	Call is in progress (WWAN only).
	The mailbox contains one or more voice message (WWAN only).
	Call is on hold (WWAN only).
	Call was missed (WWAN only).
	Wired headset with a boom module is connected to the device.
	Wired headset without a boom module is connected to the device.











**Table 3** Notification Icons (Continued)

Icon	Description
	PTT Express Voice client status. See the <a href="#">PTT Express Voice Client</a> on page 75 for more information.
	Indicates the RxLogger app is running.
	Indicates the Bluetooth scanner is connected to the device.
	Indicates the ring scanner is connected to the device in HID mode.










## Status Icons

Status icons display system information for the device.

**Table 4** Status Icons

Icon	Description
	Alarm is active.
	Main battery is fully charged.
	Main battery is partially drained.
	Main battery charge is low.
	Main battery charge is very low.
	Main battery is charging.
	All sounds, except media and alarms, are muted. Vibrate mode is active.
	All sounds except media and alarms are muted.
	Do Not Disturb mode active.
	Airplane Mode is active. All radios are turned off.

**Table 4** Status Icons (Continued)

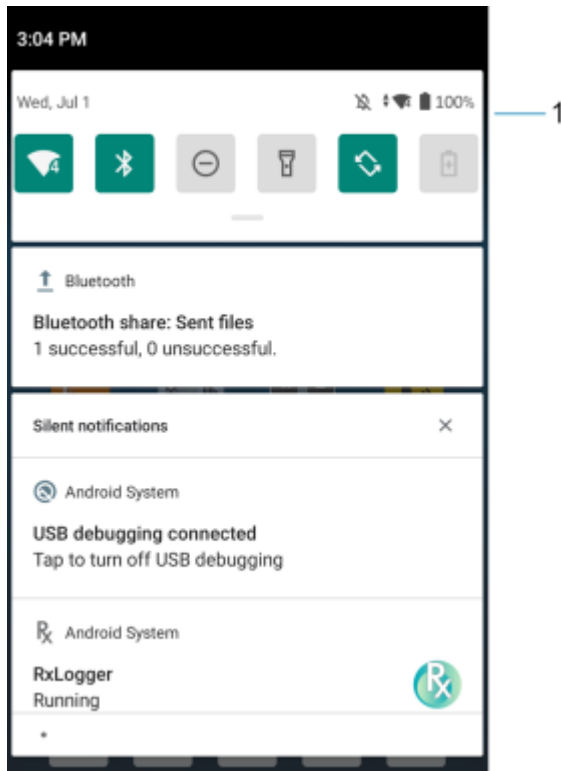
Icon	Description
	Bluetooth is on.
	Connected to a Bluetooth device.
	Connected to a Wi-Fi network. Indicates the Wi-Fi version number.
	Not connected to a Wi-Fi network or no Wi-Fi signal.
	Connected to an Ethernet network.
	Speakerphone enabled.
	Portable Wi-Fi hotspot is active (WWAN only).
	Roaming from a network (WWAN only).
	No SIM card installed (WWAN only).
<b>4G LTE</b>	Connected to a 4G LTE/LTE-CA network (WWAN only) <sup>a</sup>
<b>4G</b>	Connected to a DC-HSPA, HSDPA, HSPA+, HSUPA, LTE/LTE-CA or WCDMA network (WWAN only) <sup>a</sup>
<b>3G</b>	Connected to a 1x-RTT (Sprint), EGDGE, EVDO, EVDV or WCDMA network (WWAN only) <sup>a</sup>
<b>2G</b>	Connected to a GPRS network (WWAN only) <sup>a</sup>
<b>H</b>	Connected to a DC - HSPA, HSDPA, HSPA+, or HSUPA network (WWAN only) <sup>a</sup>
<b>E</b>	Connected to an EDGE network (WWAN only) <sup>a</sup>
<b>G</b>	Connected to a GPRS network (WWAN only) <sup>a</sup>
<b>1X</b>	Connected to a 1x-RTT (Verizon) network (WWAN only) <sup>a</sup>

<sup>a</sup>Cellular network icon that appears is dependent upon the carrier/network.

## Managing Notifications

Notification icons report the arrival of new messages, calendar events, alarms, and ongoing events. When a notification occurs, an icon appears in the Status bar with a brief description.

**Figure 9** Notification Panel

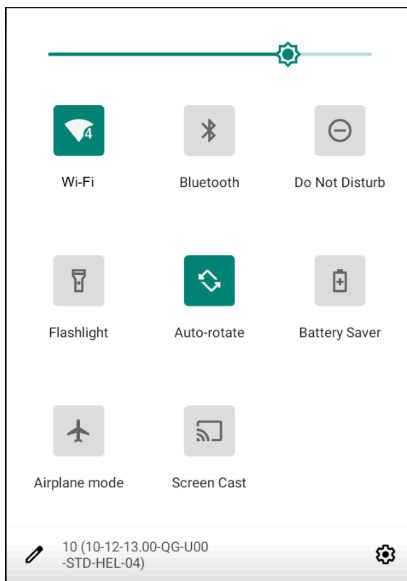


1	Quick settings bar
---	--------------------

- To view a list of all notifications, open the Notification panel by dragging the Status bar down from the top of the screen.
- To respond to a notification, open the Notification panel and then touch a notification. The Notification panel closes and the corresponding app opens.
- To manage recent or frequently used notifications, open the Notification panel and then touch Manage notifications. Touch the toggle switch next to an app to turn off all notifications, or touch an app for more notification options.
- To clear all notifications, open the Notification panel and then touch CLEAR ALL. All event-based notifications are removed. Ongoing notifications remain in the list.
- To close the Notification panel, swipe the Notification panel up.

## Opening the Quick Access Panel

Use the Quick Access panel to access frequently used settings (for example, Airplane mode).








**NOTE:** Not all icons are pictured. Icons may vary.

- If the device is locked, swipe down once.
- If the device is unlocked, swipe down once with two fingers, or twice with one finger.
- If the Notification panel is open, swipe down from the Quick Settings bar.














### Quick Access Panel Icons

Quick Access panel icons indicate frequently used settings (for example, Airplane mode).

**Table 5** Quick Access Panel Icons


Icon	Description
	Display brightness - Use the slider to decrease or increase the brightness of the screen.
	Wi-Fi network - Turn Wi-Fi on or off. To open Wi-Fi settings, touch the Wi-Fi network name.
	Bluetooth settings - Turn Bluetooth on or off. To open Bluetooth settings, touch Bluetooth.
	Battery saver - Turn Battery saver mode on or off. When Battery saver mode is on the performance of the device is reduced to preserve battery power (not applicable).
	Invert colors - Invert the display colors.

**Table 5** Quick Access Panel Icons (Continued)

Icon	Description
	Do not disturb - Control how and when to receive notifications.
	Mobile data - Turns cellular radio on or off. To open Mobile data settings, touch and hold (WWAN only).
	Airplane mode - Turn Airplane mode on or off. When Airplane mode is on the device does not connect to Wi-Fi or Bluetooth.
	Auto-rotate - Lock the device's orientation in portrait or landscape mode or set to automatically rotate.
	Flashlight - Turn flashlight on or off. Turn camera flash on or off. On camera-only devices without an internal scan engine, the flashlight turns off when an app is opened. This ensures the camera is available for scanning.
	Location - Enable or disable locationing feature.
	Hotspot - Turn on to share the device's mobile data connection with other devices.
	Data Saver - Turn on to prevent some apps from sending or receiving data in the background.
	Night Light - Tint the screen amber to make it easier to look at the screen in dim light. Set Night Light to turn on automatically from sunset to sunrise, or at other times.
	Screen Cast - Share phone content on Chromecast or a television with Chromecast built-in. Touch cast screen to display a list of devices, then touch a device to begin casting.
	Dark Theme - Toggles dark theme on and off. Dark themes reduce the luminance emitted by the screen, while meeting minimum color contrast ratios. It helps improve visual ergonomics by reducing eye strain, adjusting brightness to current lighting conditions, and facilitating screen use in dark environments, while conserving battery power.
	Focus mode - Turn on to pause distracting apps. To open Focus mode settings, touch and hold.
	Bedtime mode - Turn grayscale on and off. Grayscale turns the screen black and white, reducing phone distractions and improving battery life.

## Editing Icons on the Quick Settings Bar

The first several setting tiles from the Quick Access panel become the Quick Settings bar.

Open the Quick Access panel and touch  to edit, add, or remove settings tiles.

## Battery Management


Observe the recommended battery optimization tips for the device.

- Set the screen to turn off after a short period of inactivity.
- Reduce screen brightness.
- Turn off all wireless radios when not in use.
- Turn off automatic syncing for Email, Calendar, Contacts, and other apps.
- Minimize the use of apps that keep the device from sleeping, for example, music and video apps.



**NOTE:** Before checking the battery charge level, remove the device from any AC power source (cradle or cable).

### Checking Battery Status

- Open **Settings** and touch **About phone** > **Battery Information**. Or, swipe up from the bottom of the screen and touch  to open the **Battery Manager** app.

**Battery present status** indicates if the battery is present.

**Battery level** lists the battery charge (as a percentage of fully charged).

- Swipe down with two fingers from the status bar to open the quick access panel.

Battery percentage is displayed next to the battery icon.

### Monitoring Battery Usage

The Battery screen provides battery charge details and power management options to extend battery life. Different apps display different information. Some apps include buttons that open screens with settings to adjust power use.

- Go to **Settings**.
- Touch **Battery**.

To display battery information and power management options for a specific app:

- Go to **Settings**.
- Touch **Apps & notifications**.
- Touch an app.
- Touch **Advanced** > **Battery**.

Different apps display different information. Some apps include buttons that open screens with settings to adjust power use. Use the **DISABLE** or **FORCE STOP** buttons to turn off apps that consume too much power.

## Low Battery Notification

When the battery charge level drops below the charge level in the table below, the device displays a notice to connect the device to power. Charge the battery using one of the charging accessories.

**Table 6** Low Battery Notification

Charge Level Drops Below	Action
18%	The user should charge the battery soon.
10%	The user must charge the battery.
4%	The device turns off. The user must charge the battery.

## Interactive Sensor Technology

To take advantage of these sensors, applications use API commands. Refer to the Google Android Sensor APIs for more information. For information on the Zebra Android EMDK, go to: [techdocs.zebra.com](http://techdocs.zebra.com).

- Gyroscope - Measures angular rotational velocity to detect rotation of the device.
- Accelerometer - Measures the linear acceleration of movement to detect the orientation of the device.
- Digital Compass - The digital compass or magnetometer provides simple orientation in relation to the Earth's magnetic field. As a result, the device always knows which way is North so it can auto rotate digital maps depending on the physical orientation of the device.
- Light Sensor - Detects ambient light and adjusts the screen brightness.
- Proximity Sensor - Detects the presence of nearby objects without physical contact. The sensor detects when the device is close to your face during a call and turns off the screen, preventing unintentional screen touches.

## Waking the Device

The device goes into Sleep mode when you press **Power** or after a period of inactivity (set in the Display settings window).

1. To wake the device from Sleep mode, press **Power**.

The Lock screen displays.

2. Swipe the screen up to unlock.

- If the Pattern screen unlock feature is enabled, the Pattern screen appears instead of the Lock screen.
- If the PIN or Password screen unlock feature is enabled, enter the PIN or password after unlocking the screen.



**NOTE:** If you enter the PIN, password, or pattern incorrectly five times, you must wait 30 seconds before trying again.

- If you forget the PIN, password, or pattern, contact your system administrator.



## USB Communication

Connect the device to a host computer to transfer files between the device and the host computer.

When connecting the device to a host computer, follow the host computer's instructions for connecting and disconnecting USB devices, to avoid damaging or corrupting files.

### Transferring Files

Use Transfer files to copy files between the device and the host computer.

1. Connect the device to a host computer using a USB accessory.
2. On the device, pull down the Notification panel and touch **Charging this device via USB**.

By default, **No data transfer** is selected.

3. Touch **File Transfer**.



**NOTE:** After changing the setting to **File Transfer**, and then disconnecting the USB cable, the setting reverts back to **No data transfer**. If the USB cable is reconnected, select **File Transfer** again.

4. On the host computer, open **File Explorer**.
5. Locate the **device** as a portable device.
6. Open the SD card or the Internal storage folder.
7. Copy files to and from the device or delete files as required.

### Transferring Photos

Use PTP to copy photos from the device to the host computer.

It is recommended to install a microSD card in the device for storing photos due to limited internal storage.

1. Connect the device to a host computer using a USB accessory.
2. On the device, pull down the Notification panel and touch **Charging this device via USB**.
3. Touch **PTP**.
4. Touch **Transfer photos PTP**.
5. On the host computer, open a file explorer application.
6. Open the **Internal storage** folder.
7. Open the SD card or the Internal storage folder.
8. Copy or delete photos as required.

### Disconnecting from the Host Computer



**CAUTION:** Carefully follow the host computer's instructions to disconnect USB devices correctly to avoid losing information.



**NOTE:** Carefully follow the host computer's instructions to unmount the microSD card and disconnect USB devices correctly to avoid losing information.

1. On the host computer, unmount the device.




2. Remove the device from the USB accessory.

# Settings

This section describes the settings on the device.

## Accessing Settings

There are multiple ways to access settings on a device.

- Swipe down with two fingers from the top of the Home screen to open the Quick Access panel and touch .
- Double-swipe down from the top of the Home screen to open the Quick Access panel and touch .
- Swipe up from the bottom of the Home screen to open APPS and touch  **Settings**.

## Display Settings

Use Display settings to change the screen brightness, enable night light, change the background image, enable screen rotation, set screen timeout, and change font size.

### Setting the Screen Brightness Manually

Manually set the screen brightness using the touchscreen.

1. Swipe down with two fingers from the Status bar to open the Quick Access panel.
2. Slide the icon to adjust the screen brightness level.



### Setting the Screen Brightness Automatically

Automatically adjust the screen brightness using the built-in light sensor.

1. Go to **Settings**.
2. Touch **Display**.
3. If disabled, touch **Adaptive brightness** to automatically adjust the brightness.

By default, **Adaptive brightness** is enabled. Toggle the switch to disable.

## Setting Night Light

The Night Light setting tints the screen amber, making the screen easier to look at in low light.

1. Go to **Settings**.
2. Touch **Display**.
3. Touch **Night Light**.
4. Touch **Schedule**.
5. Select one of the schedule values:
  - None (default)
  - Turns on at custom time
  - Turns on from sunset to sunrise.
6. By default, **Night Light** is disabled. Touch **TURN ON NOW** to enable.
7. Adjust the tint using the **Intensity** slider.

## Setting Screen Rotation

By default, screen rotation is enabled.

1. Go to **Settings**.
2. Touch **Display > Advanced**.
3. Touch **Auto-rotate screen**.

To set the Home screen rotation, see [Setting Home Screen Rotation](#) on page 40.

## Setting Screen Timeout

The screen turns off and goes into Sleep mode after the selected period of inactivity.

1. Go to **Settings**.
2. Touch **Display > Advanced > Screen timeout**.
3. Select one of the screen timeout values:
  - **15 seconds**
  - **30 seconds**
  - **1 minute** (default)
  - **2 minutes**
  - **5 minutes**
  - **10 minutes**
  - **30 minutes**

## Setting Lock Screen Notifications

The lock screen display setting wakes the screen when notifications are received.

1. Go to **Settings**.

2. Touch **Display > Advanced**.
3. Touch **Lock screen**.
4. In the **When to show** section, enable or disable an option using the switch.

### Setting Touch Key Light

The four touch keys under the screen are backlit. Configure the touch key light to save battery power.

1. Go to **Settings**.
2. Touch **Display > Advanced**.
3. Touch **Key light**.
4. Select an option to choose how long the touch key light stays on:
  - Always off
  - 6 seconds (default)
  - 10 seconds
  - 15 seconds
  - 30 seconds
  - 1 minute
  - Always on.

### Setting Font Size

Set the size of the font in system apps.

1. Go to **Settings**.
2. Touch **Display > Advanced**.
3. Touch **Font size**.
4. Select an option to choose how long the touch key light stays on:
  - **Small**
  - **Default**
  - **Large**
  - **Largest**.

### Notification LED Brightness Level

1. Go to **Settings**.
2. Touch **Display > Advanced**.
3. Touch **Notification LED Brightness Level**.
4. Use the slider to set the brightness value (default: 15).

## Setting Touch Panel Mode

The device display is able to detect touches using a finger, a conductive-tip stylus, or gloved finger.



**NOTE:** A glove can be made of medical latex, leather, cotton, or wool. For optimal performance use a Zebra certified stylus.

1. Go to **Settings**.
2. Touch **Display** > **Advanced**.
3. Touch **TouchPanelUI**.
4. Select:
  - **Stylus and Finger (Screen Protector OFF)** to use a finger or a stylus on the screen without a screen protector.
  - **Glove and Finger (Screen Protector OFF)** to use a finger or a gloved finger on the screen without a screen protector.
  - **Stylus and Finger (Screen Protector ON)** to use a finger or a stylus on the screen with a screen protector.
  - **Glove and Finger (Screen Protector ON)** to use a finger or a gloved finger on the screen with a screen protector.
  - **Finger Only** to use a finger on the screen.

## Setting the Date and Time

The date and time are automatically synchronized using a NITZ server when the device is connected to a cellular network. You are only required to set the time zone or set the date and time if the wireless LAN does not support Network Time Protocol (NTP) or when not connected to a cellular network.

1. Go to **Settings**.
2. Touch **System** > **Date & time**.
3. Touch **Use network-provided time** to disable automatic date and time synchronization.
4. Touch **Use network-provided time zone** to disable automatic time zone synchronization.
5. Touch **Date** to select the date in the calendar.
6. Touch **OK**.
7. Touch **Time**.
  - a) Touch the green circle, drag to the current hour, and then release.
  - b) Touch the green circle, drag to the current minute, and then release.
  - c) Touch **AM** or **PM**.
8. Touch **Time zone** to select the current time zone from the list.
9. Touch **Update Interval** to select an interval to synchronize the system time from the network.
10. In **TIME FORMAT**, choose either **Use local default** or **Use 24-hour format**.

## General Sound Setting

Press the volume buttons on the device to display on-screen volume controls.

Use the Sound settings to configure media and alarm volumes.

1. Go to **Settings**.
2. Touch **Sound**.
3. Touch an option to set sounds.

## Sound Options

- **Media volume** - Controls the music, games, and media volume.
- **Call volume** - Controls the volume during a call.
- **Ring & notification volume** - Controls the ringtone and notification volume.
- **Alarm volume** - Controls the alarm clock volume.
- **Vibrate for calls** - Switch on or off.
- **Do Not Disturb** - Mutes some or all sounds and vibrations.
- **Media** - Shows the media player in Quick Settings while sound is playing, allowing quick access.
- **Shortcut to prevent ringing** - Turn on the switch to make the device vibrate when a call is received (default – disabled).
- **Phone ringtone** - Select a sound to play when the phone rings.
- **Default notification sound** - Select a sound to play for all system notifications.
- **Default alarm sound** - Select a sound to play for alarms.
- **Other sounds and vibrations**
  - **Dial pad tones** - Play a sound when pressing keys on dial pad (default - disabled).
  - **Screen locking sounds** - Play a sound when locking and unlocking the screen (default – enabled).
  - **Charging sounds and vibration** - Play a sound and vibrate when power is applied to the device (default - enabled).
  - **Touch sounds** - Play a sound when making screen selections (default – enabled).
  - **Touch vibration** - Vibrate the device when making screen selections (default – enabled).

## Zebra Volume Controls

In addition to the default sound settings, Zebra Volume Controls display when the volume buttons are pressed.

Zebra Volume Controls are configured using Audio Volume UI Manager (AudioVolUIMgr). Administrators can use AudioVolUIMgr to add, delete and replace Audio Profiles, select an Audio Profile to use the device, and modify the default Audio Profile. For information on how to configure Zebra Volume Controls using AudioVolUIMgr, refer to [techdocs.zebra.com](http://techdocs.zebra.com).

## Setting Wake-Up Sources

By default, the device wakes from Sleep mode when the user presses **Power**. The device can be configured to wake when the user presses **PTT** or **Scan** on the left side of the device handle.

1. Go to **Settings**.
2. Touch **Wake-Up Sources**.
  - **GUN\_TRIGGER** - Programmable button on the Trigger Handle accessory.
  - **LEFT\_TRIGGER\_2** - PTT button.
  - **RIGHT\_TRIGGER\_1** - Right scan button.
  - **SCAN** - Left scan button.
3. Touch a checkbox. A check appears in the checkbox.

## Remapping a Button

Buttons on the device can be programmed to perform different functions or as shortcuts to installed apps. For a list of key names and descriptions, refer to: [techdocs.zebra.com](http://techdocs.zebra.com).



**NOTE:** It is not recommended to remap the scan button.

1. Go to **Settings**.
2. Touch **Key Programmer**. A list of programmable buttons displays.
3. Select the button to remap.
4. Touch the **SHORTCUT**, the **KEYS and BUTTONS**, or the **TRIGGERS** tabs that list the available functions, applications, and triggers.
5. Touch a function or application shortcut to map to the button.



**NOTE:** If you select an application shortcut, the application icon appears next to the button on the Key Programmer screen.

6. If remapping the Back, Home, Search, or Menu button, perform a Soft Reset.

## Keyboards

The device provides multiple keyboard options.

- Android Keyboard - AOSP devices only
- Gboard - GMS devices only
- Enterprise Keyboard - Not pre-installed on the device. Contact Zebra Support for more information.



**NOTE:** By default, the Enterprise and Virtual Keyboards are disabled. The Enterprise Keyboard is available for download from the [Zebra Support Site](http://Zebra Support Site).

## Keyboard Configuration

This section describes configuring the device's keyboard.



## Enabling Keyboards




1. Go to **Settings**.
2. Touch **System** > **Languages & input** > **Virtual keyboard** > **Manage keyboards**.
3. Touch a keyboard to enable.

## Switching Between Keyboards

To switch between keyboards, touch in a text box to display the current keyboard.



**NOTE:** By default, the Gboard is enabled. All other virtual keyboards are disabled.

- On the Gboard keyboard, touch and hold  (GMS devices only).
- On the Android keyboard, touch, and hold  (AOSP devices only).
- On the Enterprise keyboard, touch . Only available with Mobility DNA Enterprise License. Not pre-installed on the device. Contact Zebra Support for more information.

## Using the Android and Gboard Keyboards


Use the Android or Gboard keyboards to enter text in a text field.

- To configure the keyboard settings, touch and hold "," (comma) and then select **Android keyboard settings**.

## Edit Text

Edit entered text and use menu commands to cut, copy, and paste text within or across apps. Some apps do not support editing some or all of the text they display; others may offer their own way to select text.

## Entering Numbers, Symbols, and Special Characters

1. Enter numbers and symbols.
  - Touch and hold one of the top-row keys until a menu appears then select a number or special character.
  - Touch the Shift key once for a single capital letter. Touch the Shift key twice to lock in uppercase. Touch the Shift key a third time to unlock Capslock.
  - Touch **?123** to switch to the numbers and symbols keyboard.
  - Touch the  key on the numbers and symbols keyboard to view additional symbols.
2. Enter special characters.
  - Touch and hold a number or symbol key to open a menu of additional symbols. A larger version of the key displays briefly over the keyboard.

## Enterprise Keyboard

The Enterprise Keyboard contains multiple keyboard types.



**NOTE:** Only available with Mobility DNA Enterprise License.

- Numeric
- Alpha
- Special characters
- Data capture.

### Numeric Tab

The numeric keyboard is labeled **123**. The keys displayed vary on the app being used. For example, an arrow displays in **Contacts**, however **Done** displays in **Email** account setup.

### Alpha Tab

The alpha keyboard is labeled using the language code. For English, the alpha keyboard is labeled **EN**.

### Additional Character Tab

The additional characters keyboard is labeled **#\*/**.

- Touch 😊 to enter emoji icons in a text message.
- Touch **ABC** to return to the Symbols keyboard.

### Scan Tab

The Scan tab provides an easy data capture feature for scanning barcodes.

## Language Usage

Use the **Language & input** settings to change the device's language, including words added to the dictionary.

### Changing the Language Setting

1. Go to **Settings**.
2. Touch **System** > **Languages & input**.
3. Touch **Languages**. A list of available languages displays.
4. If the desired language is not listed, touch **Add a language** and select a language from the list.
5. Touch and hold **≡** to the right of the desired language, then drag it to the top of the list.
6. The operating system text changes to the selected language.

## Adding Words to the Dictionary

1. Go to **Settings**.
2. Touch **System > Languages & input > Advanced > Personal dictionary** .
3. If prompted, select the language where this word or phrase is stored.
4. Touch + to add a new word or phrase to the dictionary.
5. Enter the word or phrase.
6. In the Shortcut text box, enter a shortcut for the word or phrase.

## Notifications

The user can configure notifications for the device and for specific apps. Device notifications settings allow the user to configure how notifications occur on the device. App notification settings allow the user to configure how notifications for a specific app occur.

To view device notification settings, touch **Settings > Apps & notifications > Notifications**. To view app notifications, **Settings > Apps & notifications > App info**, and then select an app.

## Setting App Notifications

Configure the notifications settings for a specific app.

1. Go to **Settings**.
2. Touch **Apps & notifications > SEE ALL XX APPS** . The App info screen displays.
3. Select an app.
4. Touch **Notifications**.

Options vary depending on the app selected.

5. Select an available option:

**Show notifications** - Select to turn all notifications from this app on (default) or off. Touch a notification category to display additional options.

- **Alerting** - Allow notifications from this app to make sound or vibrate the device.
  - **Pop on screen** - Allow notifications from this app to pop notifications on the screen.
- **Silent** - Do not allow notifications from this app to make sound or vibrate.
  - **Minimize** - In the Notification panel, collapse notifications to one line.
- **Advanced** - Touch for additional options.
  - **Sound** - Select a sound to play for notifications from this app.
  - **Vibrate** - Allow notifications from this app to vibrate the device.
  - **Blink light** - Allow notifications from this app the light the Notification LED blue.
  - **Show notification dot** - Allow notifications from this app to add a notification dot to the app icon.
  - **Override Do Not Disturb** - Allow these notifications to interrupt when Do Not Disturb is enabled.

**Advanced**

- **Allow notification dot** - Do not allow this app to add a notification dot to the app icon.
- **Additional settings in the app** - Open the app settings.

## Viewing Notifications

1. Go to **Settings**.
2. Touch **Apps & Notifications**.
3. Scroll down to **Notifications** to view how many apps have notifications turned off.

## Controlling Lock Screen Notifications

Control whether notifications can be seen when the device is locked

1. Go to **Settings**.
2. Touch **Apps & notifications > Notifications** .
3. Touch **Notifications on lockscreen** and select one of the following:
  - **Show alerting and silent notifications (default)**
  - **Show alerting notifications only**
  - **Don't show notifications.**

## Enabling Blink Light

The Notification LED lights blue when an app, such as email and VoIP, generates a programmable notification or to indicate when the device is connected to a Bluetooth device. By default, LED notifications are enabled.

1. Go to **Settings**.
2. Touch **Apps & notifications > Notifications > Advanced** .

3. Touch **Blink light** to toggle the notification on or off.








# Applications

The APPS screen displays icons for all installed apps. See Application Deployment for information on installing and uninstalling apps. For information on standard Android apps, go to the Google Play [Apps store](#).









## Installed Applications

Apart from the standard pre-installed Android applications, the following table lists Zebra-specific applications installed on the device.

**Table 7** Apps

Icon	Description
	<b>Battery Manager</b> - Displays battery information, including charge level, status, health and wear level.
	<b>Bluetooth Pairing Utility</b> – Use to pair a Zebra Bluetooth scanner with the device by scanning a barcode.
	<b>Camera</b> - Take photos or record videos.
	<b>DataWedge</b> - Enables data capture using the imager.
	<b>DisplayLink Presenter</b> - Use to present the device screen onto a connected monitor.
	<b>DWDemo</b> - Provides a way to demonstrate the data capture features using the imager.
	<b>License Manager</b> - Use to manage software licenses on the device.

**Table 7** Apps (Continued)


Icon	Description
	<b>Phone</b> - Use to dial a phone number when used with some Voice over IP (VoIP) clients (VoIP telephony ready only). WAN devices only.
	<b>RxLogger</b> - Use to diagnose device and app issues.
	<b>Settings</b> - Use to configure the device.
	<b>StageNow</b> - Allows the device to stage a device for initial use by initiating the deployment of settings, firmware, and software.
	<b>VoD</b> - The Video on Device basic app provides a how-to video for proper device cleaning. For Video on Device licensing information, go to <a href="http://learning.zebra.com">learning.zebra.com</a> .
	<b>Worry Free Wifi Analyzer</b> - A diagnostic intelligent app. Use to diagnose surrounding area and display network stats, such as coverage hole detection, or AP in the vicinity. Refer to the Worry Free Wi-Fi Analyzer Administrator Guide for Android.
	<b>Zebra Bluetooth Settings</b> - Use to configure Bluetooth logging.
	<b>Zebra Data Services</b> - Use to enable or disable Zebra Data Services. Some options are set by the system administrator.

## Accessing Apps

Access all apps installed on the device using the APPS window.

1. On the Home screen, swipe up from the bottom of the screen.
2. Slide the **APPS** window up or down to view more app icons.
3. Touch an icon to open the app.

## Switching Between Recent Apps

1. Touch **Recent**.  
A window appears on the screen with icons of recently used apps.
2. Touch .  
A window appears on the screen with icons of recently used apps.


3. Slide the apps displayed up and down to view all recently used apps.
4. Swipe left or right to remove the app from the list and force close the app.
5. Touch an icon to open an app or touch Back to return to the current screen.

## Battery Manager

The Battery Manager provides detailed information about the battery.

This section also provides battery swap procedures for supported devices.




### Opening Battery Manager


- To open the Battery Manager app, swipe up from the bottom of the Home screen, and then touch .

### Battery Manager Information Tab

The Battery Manager displays detailed information about battery charging, health, and status.

**Table 8** Battery Icons

Battery Icon	Description
	Battery charge level is between 85% and 100%.
	Battery charge level is between 19% and 84%.
	Battery charge level is between 0% and 18%.

- **Level** - The current battery charge level as a percentage. Displays -% when the level is unknown.
- **Wear** - The health of the battery in graphical form. When the wear level exceeds 80%, the bar color changes to red.
- **Health** - The health of the battery. If a critical error occurs,  appears. Touch to view the error description.
  - **Decommission** - The battery is past its useful life and should be replaced. See system administrator.
  - **Good** - The battery is good.
  - **Charge error** - An error occurred while charging. See system administrator.
  - **Over Current** - An over-current condition occurred. See system administrator.
  - **Dead** - The battery has no charge. Replace the battery.
  - **Over Voltage** - An over-voltage condition occurred. See system administrator.
  - **Below Temperature** - The battery temperature is below the operating temperature. See system administrator.
  - **Failure Detected** - A failure has been detected in the battery. See system administrator.
  - **Unknown** - See system administrator.



- **Charge Status**
  - **Not charging** - The device is not connected to AC power.
  - **Charging-AC** - The device is connected to AC power and charging or is fast charging via USB.
  - **Charging-USB** - The device is connected to a host computer with a USB cable and charging.
  - **Discharging** - The battery is discharging.
  - **Full** - The battery is fully charged.
  - **Unknown** - The battery status is unknown.
- **Time until Full** - The amount of time until the battery is fully charged.
- **Time since charging** - The amount of time since the device began charging.
- **Time until empty** - The amount of time until the battery is empty.
- **Advanced info** - Touch to view additional battery information.
  - **Battery present status** - Indicates that the battery is present.
  - **Battery scale** - The battery scale level used to determine battery level (100).
  - **Battery level** - The battery charge level as a percentage of scale.
  - **Battery voltage** - The current battery voltage in millivolts.
  - **Battery temperature** - The current battery temperature in degrees Centigrade.
  - **Battery technology** - The type of battery.
  - **Battery current** - The average current into or out of the battery over the last second in mAh.
  - **Battery manufacture date** - The date of manufacture.
  - **Battery serial number** - The battery serial number. The number matches the serial number printed on the battery label.
  - **Battery part number** - The battery part number.
  - **Battery decommission status** - Indicates if the battery is past its life span.
    - **Battery Good** - The battery is in good health.
    - **Decommissioned Battery** - The battery is past its useful life and should be replaced.
  - **Base cumulative charge** - Cumulative charge using Zebra charging equipment only.
  - **Battery present capacity** - Maximum amount of charge that could be pulled from the battery under the present discharge conditions if the battery were fully charged.
  - **Battery health percentage** - With a range from 0 to 100, this is the ratio of “present\_capacity” to “design\_capacity” at a discharge rate of “design\_capacity”.
  - **% decommission threshold** - The default % decommission threshold for a gifted battery as 80%.
  - **Battery present charge** - Amount of usable charge remaining in the battery at present under the current discharge conditions.
  - **Battery total cumulative charge** - The total accumulated charge in all chargers.
  - **Battery time since first use** - The time passed since the battery was placed in a Zebra terminal for the first time.
  - **Battery error status** - The error status of the battery.
  - **App version** - The application version number.

## Battery Manager Swap Tab

Use to place the device in Battery Swap mode when replacing the battery. Follow the instructions on the screen. Touch **Proceed with battery swap** button.



**NOTE:** The Swap tab also appears when the user presses the Power button and selects Battery Swap.

## Camera

This section provides information for taking photos and recording videos using the integrated digital cameras.





**NOTE:** The device saves photos and videos on the microSD card, if installed and the storage path is changed manually. By default, or if a microSD card is not installed, the device saves photos and videos on internal storage.


## Taking Photos

1. Swipe up from the bottom of the Home screen and touch **Camera**.



1	Scene mode
2	Filters
3	Camera switch
4	HDR
5	Settings
6	Camera mode
7	Shutter button
8	Gallery

2. If necessary, touch the Camera Mode icon and touch .
3. To switch between the rear camera and front camera (if available), touch .
4. Frame the subject on the screen.

5. To zoom in or out, press two fingers on the display and pinch or expand your fingers. The zoom controls appear on the screen.
6. Touch an area on the screen to focus. The focus circle appears. The two bars turn green when in focus.
7. Touch .

The camera takes a photo and a shutter sound plays.




The photo momentarily displays as a thumbnail in the lower-left corner.

### Taking a Panoramic Photo


Panorama mode creates a single wide image by panning slowly across a scene.

1. Swipe up from the bottom of the Home screen and touch **Camera**.




2. Touch the Camera Mode icon and touch .
3. Frame one side of the scene to capture.
4. Touch  and slowly pan across the area to capture. A small white square appears inside the button indicating the capture is in progress.  
If you are panning too quickly, the message **Too fast** appears.
5. Touch  to end the shot. The panorama appears immediately and a progress indicator displays while it saves the image.



## Recording Videos

1. Swipe up from the bottom of the Home screen and touch **Camera**.
2. Touch the camera mode menu and touch .




1	Color effect
2	Camera switch
3	Audio
4	Settings
5	Camera mode
6	Shutter button
7	Gallery

3. To switch between the rear camera and front camera (if available), touch .
4. Point the camera and frame the scene.

5. To zoom in or out, press two fingers on the display and pinch or expand fingers. The zoom controls appear on the screen.
6. Touch  to start recording.  
The video time remaining appears in the top left of the screen.
7. Touch  to end the recording.  
The video momentarily displays as a thumbnail in the lower left corner.




## Photo Settings

In Photo mode, photo settings appear on screen.

Touch  to display the photo settings options.






### Rear Camera Photo Settings

- **Flash** - Select whether the camera relies on its light meter to decide whether a flash is necessary, or to turn it on or off for all shots.

Icon	Description
	<b>Off</b> - Disable flash.
	<b>Auto</b> - Adjust flash automatically depending upon light meter (default).
	<b>On</b> - Enable flash upon taking a photo.

- **GPS location** - Add GPS location information to the photo meta-data. Turn On or Off (default). (WAN only).
- **Picture size** - The size (in pixels) of the photo to: 13M pixels (default), 8M pixels, 5M pixels, 3M pixels, HD 1080, 2M pixels, HD720, 1M pixels, WVGA, VGA, or QVGA.
- **Picture quality** - Set the picture quality setting to: Low, Standard (default) or High.
- **Countdown timer** - Select Off (default), 2 seconds, 5 seconds or 10 seconds.
- **Storage** – Set the location to store the photo to: Phone or SD Card.
- **Continuous Shot** - Select to take a series of photos quickly while holding the capture button. Off (default) or On.
- **Face Detection** - Set the camera to automatically adjust the focus for faces.
- **ISO** - Set camera sensitivity to light to: Auto (default), ISO Auto (HJR), ISO100, ISO200, ISO400, ISO800 or ISO1600.
- **Exposure** - Set the exposure settings to: +2, +1, 0(default), -1 or -2.

- **White balance** - Select how the camera adjusts colors in different kinds of light, to achieve the most natural-looking colors.






Icon	Description
	<b>Incandescent</b> - Adjust the white balance for incandescent lighting.
	<b>Fluorescent</b> - Adjust the white balance for florescent lighting.
	<b>Auto</b> - Adjust the white balance automatically (default).
	<b>Daylight</b> - Adjust the white balance for daylight.
	<b>Cloudy</b> - Adjust the white balance for a cloudy environment.

- **Redeye reduction** - Helps eliminate redeye effect. Options: Disabled (default), or Enable.
- **ZSL** - Set the camera to immediately take a picture when the button is pressed (default – enabled).
- **Shutter Sound** - Select to play a shutter sound when taking a photo. Options: Disable (default) or Enable.
- **Anti Banding** - Allows the camera to avoid problems caused by artificial light sources that are not constant. These sources cycle (flicker) fast enough to go unnoticed to the human eye, appearing continuous. The camera’s eye (its sensor) can still see this flicker. Options: Auto (default), 60 Hz, 50 Hz, or Off.

## Front Camera Photo Settings


- **Selfie Flash** - Turns the screen white to help produce a little extra light in dimmer settings. Options: Off (default), or On.
- **GPS location** - Add GPS location information to the photo meta-data. Options: On or Off (default). (WAN only).
- **Picture size** - Set the size (in pixels) of the photo to: 5M pixels (default), 3M pixels, HD1080, 2M pixels, HD720, 1M pixels, WVGA, VGA, or QVGA.
- **Picture quality** - Set the picture quality setting to: Low, Standard or High (default).
- **Countdown timer** - Set to: Off (default), 2 seconds, 5 seconds or 10 seconds.
- **Storage** – Set location to store the photo to: Phone or SD Card.
- **Continuous Shot** - Select to take a series of photos quickly while holding the capture button. Off (default) or On.
- **Face Detection** - Select to turn face detection Off (default) or On.
- **ISO** - Set how sensitive the camera is to light. Options: Auto (default), ISO Auto (HJR), ISO100, ISO200, ISO400, ISO800 or ISO1600.
- **Exposure** - Touch to adjust the exposure settings. Options: +2, +1, 0 (default), -1 or -2.

- **White balance** - Select how the camera adjusts colors in different kinds of light, to achieve the most natural-looking colors.

Icon	Description
	<b>Incandescent</b> - Adjust the white balance for incandescent lighting.
	<b>Fluorescent</b> - Adjust the white balance for fluorescent lighting.
	<b>Auto</b> - Adjust the white balance automatically (default).
	<b>Daylight</b> - Adjust the white balance for daylight.
	<b>Cloudy</b> - Adjust the white balance for a cloudy environment.



- **Redeye reduction** - Helps eliminate redeye effect. Options: Disabled (default), or Enable.
- **ZSL** - Set the camera to immediately take a picture when the button is pressed (default – enabled)
- **Selfie Mirror** - Select to save a mirror image of the photo. Options: Disable (default), or Enable.
- **Shutter Sound** - Select to play a shutter sound when taking a photo. Options: Disable (default) or Enable.
- **Anti Banding** - Allows the camera to avoid problems caused by artificial light sources that are not constant. These sources cycle (flicker) fast enough to go unnoticed to the human eye, appearing continuous. The camera's eye (its sensor) can still see this flicker. Options: Auto (default), 60 Hz, 50 Hz, or Off.

## Video Settings

In Video mode, video settings appear on screen. Touch  to display the video settings options.

### Rear Camera Video Settings






- **Flash** - Select whether Rear-facing Camera relies on its light meter to decide whether a flash is necessary, or to turn it on or off for all shots.

Icon	Description
	<b>Off</b> - Disable flash.
	<b>On</b> - Enable flash upon taking a photo.

- **Video quality** - Set video quality to: 4k DCI, 4k UHD, HD 1080p (default), HD 720p, SD 480p, VGA, CIF, or QVGA.
- **Video duration** - Set to: 30 seconds (MMS), 10 minutes, or 30 minutes (default), or no limit.







- **GPS location** - Add GPS location information to the photo meta-data. Turn On or Off (default). (WAN only).
- **Storage** – Set the location to store the photo to: Phone (default) or SD Card.
- **White balance**- Select how the camera adjusts colors in different kinds of light, to achieve the most natural-looking colors.


Icon	Description
	<b>Incandescent</b> - Adjust the white balance for incandescent lighting.
	<b>Fluorescent</b> - Adjust the white balance for florescent lighting.
	<b>Auto</b> - Adjust the white balance automatically (default).
	<b>Daylight</b> - Adjust the white balance for daylight.
	<b>Cloudy</b> - Adjust the white balance for a cloudy environment.

- **Image Stabilization** - Set to reduce blurry videos due to device movement. Options: On or Off (default).

### Front Camera Video Settings

- **Video quality** - Set video quality to: 4k DCI, 4k UHD, HD 1080p (default), HD 720p, SD 480p, VGA, CIF, or QVGA.
- **Video duration** - Set to: 30 seconds (MMS), 10 minutes, or 30 minutes (default), or no limit.
- **GPS location** - Add GPS location information to the photo meta-data. Turn On or Off (default). (WAN only).
- **Storage** – Set the location to store the photo to: Phone (default) or SD Card.
- **White balance**- Select how the camera adjusts colors in different kinds of light, to achieve the most natural-looking colors.

Icon	Description
	<b>Incandescent</b> - Adjust the white balance for incandescent lighting.
	<b>Fluorescent</b> - Adjust the white balance for florescent lighting.
	<b>Auto</b> - Adjust the white balance automatically (default).
	<b>Daylight</b> - Adjust the white balance for daylight.

Icon	Description
	<b>Cloudy</b> - Adjust the white balance for a cloudy environment.










- **Image Stabilization** - Set to reduce blurry videos due to device movement. Options: On or Off (default).

## DataWedge Demonstration

Use DataWedge Demonstration (DWDemo) to demonstrate data capture functionality. To configure DataWedge, refer to [techdocs.zebra.com/datawedge/](http://techdocs.zebra.com/datawedge/).


### DataWedge Demonstration Icons

**Table 9** DataWedge Demonstration Icons

Category	Icon	Description
Illumination		Imager illumination is on. Touch to turn illumination off.
Illumination		Imager illumination is off. Touch to turn illumination on.
Data Capture		The data capture function is through the internal imager.
Data Capture		An RS507 or RS6000 Bluetooth imager is connected.
Data Capture		An RS507 or RS6000 Bluetooth imager is not connected.
Data Capture		The data capture function is through the rear camera.
Scan Mode		Imager is in picklist mode. Touch to change to normal scan mode.
Scan Mode		Imager is in normal scan mode. Touch to change to picklist mode.
Menu		Opens a menu to view the application information or to set the application DataWedge profile.

### Selecting a Scanner

See [Data Capture](#) for more information.

1. To select a scanner, touch  > **Settings** > **Scanner Selection**.
2. Press the programmable button or touch the yellow scan button to capture data. The data appears in the text field below the yellow button.

## PTT Express Voice Client

PTT Express Voice Client enables Push-To-Talk (PTT) communication between disparate enterprise devices. Leveraging existing Wireless Local Area Network (WLAN) infrastructure, PTT Express delivers simple PTT communication without requiring a voice communication server.



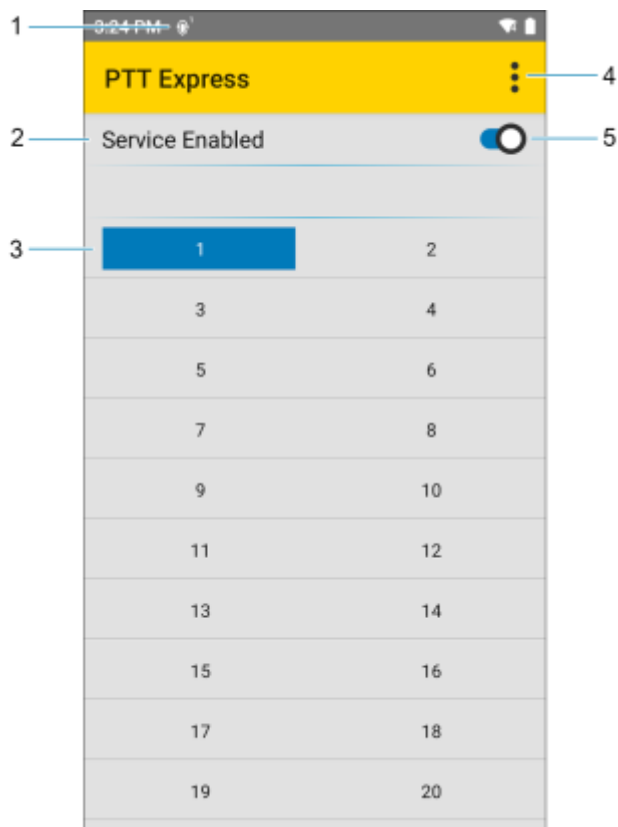
**NOTE:** Requires a PTT Express License.

- **Group Call** - Press and hold **PTT (Talk)** to start communicating with other voice client users.
- **Private Response** - Double-press **PTT** to respond to the originator of the last broadcast or to make a Private Response.

## PTT Express User Interface

Use the PTT Express interface for Push-To-Talk communication.

**Figure 10** PTT Express Default User Interface



Number	Item	Description
1	Notification icon	Indicates the current state of the PTT Express client.
2	Service indication	Indicates the status of the PTT Express client. Options are: Service Enabled, Service Disabled or Service Unavailable.
3	Talk group	Lists all 32 Talk Groups available for PTT communication.

Number	Item	Description
4	Settings	Opens the PTT Express Settings screen.
5	Enable/disable switch	Turns the PTT service on and off.

## PTT Audible Indicators








The following tones provide helpful cues when using the voice client.

- **Talk Tone:** Double chirp. Plays when the Talk button is depressed. This is a prompt for you to start talking.
- **Access Tone:** Single beep. Plays when another user just finished a broadcast or response. You can now initiate a Group Broadcast or Private Response.
- **Busy Tone:** Continuous tone. Plays when the Talk button is depressed and another user is already communicating on the same talkgroup. Plays after the maximum allowed talk time is reached (60 seconds).
- **Network Tone:**
  - Three increasing pitch beeps. Plays when PTT Express acquires the WLAN connection and the service is enabled.
  - Three decreasing pitch beeps. Plays when PTT Express loses the WLAN connection or the service is disabled.


## PTT Notification Icons

Notification icons indicate the current state of the PTT Express Voice client.

**Table 10** PTT Express Icons

Status Icon	Description
	The PTT Express Voice client is disabled.
	The PTT Express Voice client is enabled but not connected to a WLAN.
	The PTT Express Voice client is enabled, connected to a WLAN, and listening on the Talk Group indicated by the number next to the icon.
	The PTT Express Voice client is enabled, connected to a WLAN, and communicating on the Talk Group indicated by the number next to the icon.
	The PTT Express Voice client is enabled, connected to a WLAN, and in a private response.
	The PTT Express Voice client is enabled and muted.
	The PTT Express Voice client is enabled but it is not able to communicate due to a VoIP telephony call in progress.

## Enabling PTT Communication

1. Swipe up from the bottom of the Home screen and touch .
2. Slide the Enable/Disable Switch to the **ON** position. The button changes to **ON**.

## Selecting a Talk Group

There are 32 Talk Groups that can be selected by PTT Express users. However, only one talk group can be enabled at a time on the device.

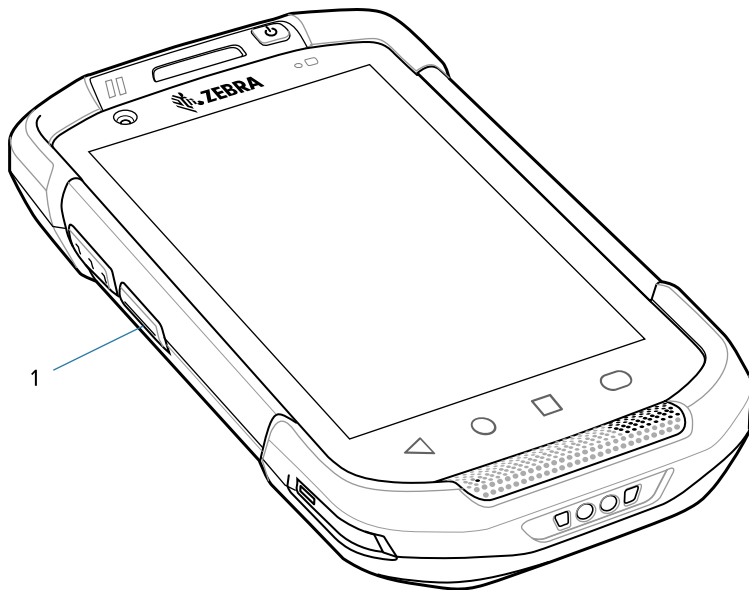
- Touch one of the 32 Talk Groups. The selected Talk Group is highlighted.

## PTT Communication

This section describes the default PTT Express client configuration. Refer to the PTT Express V1.2 User Guide for detailed information on using the client.

PTT communication may be established as a Group Call. When PTT Express is enabled, the PTT button on the left side of the device is assigned for PTT communication. When the Wired Headset is used, Group Calls can also be initiated using the headset Talk button.

**Figure 11** PTT Button



1	PTT button
---	------------

## Creating a Group Call

1. Press and hold **PTT (1)** (or **Talk** on the headset) and listen for the talk tone.

If you hear a busy tone, release the button and wait a moment before making another attempt. Ensure that PTT Express and the WLAN are enabled.



**NOTE:** Holding the button for more than 60 seconds (default) drops the call, allowing others to make Group calls. Release the button when finished talking to allow others to make calls.


2. Start talking after hearing the talk tone.
3. Release the button when finished talking.

### Responding with a Private Response

The Private Response can only be initiated once a Group Call has been established. The initial Private Response is made to the originator of the Group Call.

1. Wait for an access tone.
2. Within 10 seconds, double-press **PTT**, and listen for the talk tone.
3. If you hear a busy tone, release the button and wait a moment before making another attempt. Ensure that PTT Express and the WLAN are enabled.
4. Start talking after the talk tone plays.
5. Release the button when finished talking.

### Disabling PTT Communication

1. Swipe up from the bottom of the Home screen and touch .
2. Slide the **Enable/Disable Switch** to the **OFF** position. The button changes to **OFF**.

## RxLogger

RxLogger is a comprehensive diagnostic tool that provides application and system metrics, and diagnoses device and application issues.

RxLogger logs the following information: CPU load, memory load, memory snapshots, battery consumption, power states, wireless logging, cellular logging, TCP dumps, Bluetooth logging, GPS logging, logcat, FTP push/pull, ANR dumps, etc. All generated logs and files are saved onto flash storage on the device (internal or external).

### RxLogger Configuration

RxLogger is built with an extensible plug-in architecture and comes packaged with a number of plug-ins already built-in. For information on configuring RxLogger, refer to [techdocs.zebra.com/rxlogger/](http://techdocs.zebra.com/rxlogger/).

To open the configuration screen, from the RxLogger home screen touch **Settings**.

### Configuration File

RxLogger configuration can be set using an XML file.


The config.xml configuration file is located on the microSD card in the RxLogger\config folder. Copy the file from the device to a host computer using a USB connection. Edit the configuration file and then replace the XML file on the device. There is no need to stop and restart the RxLogger service since the file change is automatically detected.

### Enabling Logging

1. Swipe the screen up and select .

2. Touch **Start**.

## Disabling Logging


1. Swipe the screen up and select .
2. Touch **Stop**.

## Extracting Log Files

1. Connect the device to a host computer using a USB connection.
2. Using a file explorer, navigate to the RxLogger folder.
3. Copy the file from the device to the host computer.
4. Disconnect the device from the host computer.

## Backing Up Data


RxLogger Utility allows the user to make a zip file of the RxLogger folder in the device, which by default contains all the RxLogger logs stored in the device.

- To save the backup data, touch  > **BackupNow**.

## RxLogger Utility

RxLogger Utility is a data monitoring application for viewing logs in the device while RxLogger is running. Logs and RxLogger Utility features are accessed using Main Chat Head.

### Initiating the Main Chat Head

1. Open **RxLogger**.
2. Touch  > **Toggle Chat Head**.  
The Main Chat Head icon appears on the screen.
3. Touch and drag the Main Chat Head icon to move it around the screen.

### Removing the Main Chat Head

1. Touch and drag the icon.  
A circle with an X appears.
2. Move the icon over the circle and then release.

### Viewing Logs

1. Touch the Main Chat Head icon.  
The RxLogger Utility screen appears.
2. Touch a log to open it.  
The user can open many logs with each displaying a new Sub Chat Head.

3. If necessary, scroll left or right to view additional Sub Chat Head icons.
4. Touch a Sub Chat Head to display the log contents.

### Removing a Sub Chat Head Icon

- To remove a Sub Chat Head icon, press and hold the icon until it disappears.

### Backing Up In Overlay View

RxLogger Utility allows the user to make a zip file of the RxLogger folder in the device, which by default contains all the RxLogger logs stored in the device.

The Backup icon is always available in Overlay View.

1. Touch .

The Backup dialog box appears.

2. Touch **Yes** to create the backup.



# Data Capture

This section provides information for capturing barcode data using various scanning options.

The device supports data capture using:

- Integrated Imager
- Integrated Camera
- RS507/RS507X Hands-free Imager
- RS5100 Bluetooth Ring Scanner
- RS6000 Hands-free Imager
- DS2278 Digital Scanner
- DS3578 Bluetooth scanner
- DS3608 USB scanner
- DS3678 Digital Scanner
- DS8178 Digital Scanner
- LI3678 Linear Scanner

## Imaging

The device with an integrated 2D imager has the following features:

- Omnidirectional reading of a variety of barcode symbologies, including the most popular linear, postal, PDF417, Digimarc, and 2D matrix code types.
- The ability to capture and download images to a host for a variety of imaging applications.
- Advanced intuitive laser aiming cross-hair and dot aiming for easy point-and-shoot operation.

The imager uses imaging technology to take a picture of a barcode, stores the resulting image in memory, and executes state-of-the-art software decoding algorithms to extract the barcode data from the image.

## Digital Camera

The device with an integrated camera based barcode scanning solution has the following features:

- Omnidirectional reading of a variety of barcode symbologies, including the most popular linear, postal, QR, PDF417, and 2D matrix code types.

- Cross-hair reticle for easy point-and-shoot operation.
- Picklist mode to decode a particular barcode from many in the field of view.

The solution uses the advanced camera technology to take a digital picture of a barcode, and executes state-of-the-art software decoding algorithms to extract the data from the image.

## Linear Imager

The device with an integrated linear imager has the following features:

- Reading a variety of barcode symbologies, including the most popular 1-D code types.
- Intuitive aiming for easy point-and-shoot operation.

The imager uses imaging technology to take a picture of a barcode, stores the resulting image in its memory, and executes state-of-the-art software decoding algorithms to extract the barcode data from the image.

## Operational Modes

The device with an integrated imager supports three modes of operation.

Activate each mode by pressing **Scan**.

- Decode mode — The device attempts to locate and decode enabled barcodes within its field of view. The imager remains in this mode as long as you hold the scan button, or until it decodes a barcode.



**NOTE:** To enable Picklist Mode, configure in DataWedge or set in an application using an API command.

- Picklist mode — Selectively decode a barcode when more than one barcode is in the device's field of view by moving the aiming crosshair or dot over the required barcode. Use this feature for pick lists containing multiple barcodes and manufacturing or transport labels containing more than one barcode type (either 1D or 2D).



**NOTE:** To enable MultiBarcode Mode, configure in DataWedge or set in an application using an API command.

- MultiBarcode Mode — In this mode, the device attempts to locate and decode a specific number of unique barcodes within its field of view. The device remains in this mode as long as the user holds the scan button, or until it decodes all the barcodes.
  - The device attempts to scan the programmed number of unique barcodes (from 2 through 100). This may be a fixed amount, meaning it scans X unique barcodes, or can be set as a range to scan a different number of unique barcodes each session.
  - If there are duplicate barcodes (same symbology type and data), only one of the duplicate barcodes is decoded and the remainder are ignored. If the label has two duplicate barcodes plus another two different barcodes, a maximum of three barcodes will be decoded from that label; one will be ignored as a duplicate.
  - Barcodes can be of multiple symbology types and still be acquired together. For example, if the specified quantity for a MultiBarcode Mode scan is four, two barcodes can be symbology type Code 128 and the other two can be symbology type Code 39.
  - If the specified number of unique barcodes is not initially in view of the device, the device will not decode any data until the device is moved to capture the additional barcode(s) or time out occurs. If the device field of view contains a number of barcodes greater than the specified quantity, the

device randomly decodes barcode(s) until the specified number of unique barcodes is reached. For example, if the count is set to two and eight barcodes are in the field of view, the device decodes the first two unique barcodes it sees, returning the data in random order.

- MultiBarcode Mode does not support concatenated barcodes.

## Scanning Considerations

Typically, scanning is a simple matter of aim, scan, and decode, with a few quick trial efforts to master it. However, consider the following to optimize scanning performance:

- **Range** — Scanners decode best over a particular working range — minimum and maximum distances from the barcode. This range varies according to barcode density and scanning device optics. Scan within range for quick and constant decodes; scanning too close or too far away prevents decodes. Move the scanner closer and further away to find the right working range for the barcodes being scanned.
- **Angle** — Scanning angle is important for quick decodes. When the illumination/flash reflects directly back into the imager, the specular reflection can blind/saturate the imager. To avoid this, scan the barcode so that the beam does not bounce directly back. Do not scan at too sharp an angle; the scanner needs to collect scattered reflections from the scan to make a successful decode. Practice quickly shows what tolerances to work within.
- Hold the device farther away for larger symbols.
- Move the device closer for symbols with bars that are close together.



**NOTE:** Scanning procedures depend on the app and device configuration. An app may use different scanning procedures from the one listed above.

## Scanning with Internal Imager

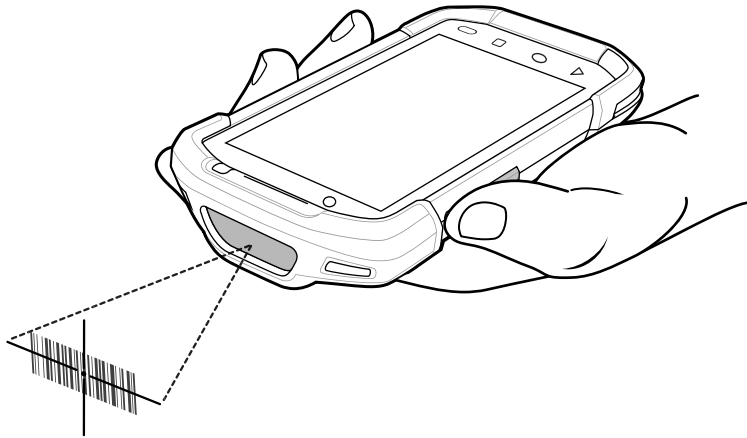
Use the internal imager to capture barcode data.



**NOTE:** To read a barcode, a scan-enabled app is required. The device contains the DataWedge app that allows the user to enable the scanner to decode barcode data and display the barcode content.

1. Ensure that an application is open on the device and a text field is in focus (text cursor in text field).

2. Point the exit window of the device at a barcode.



3. Press and hold the scan button.

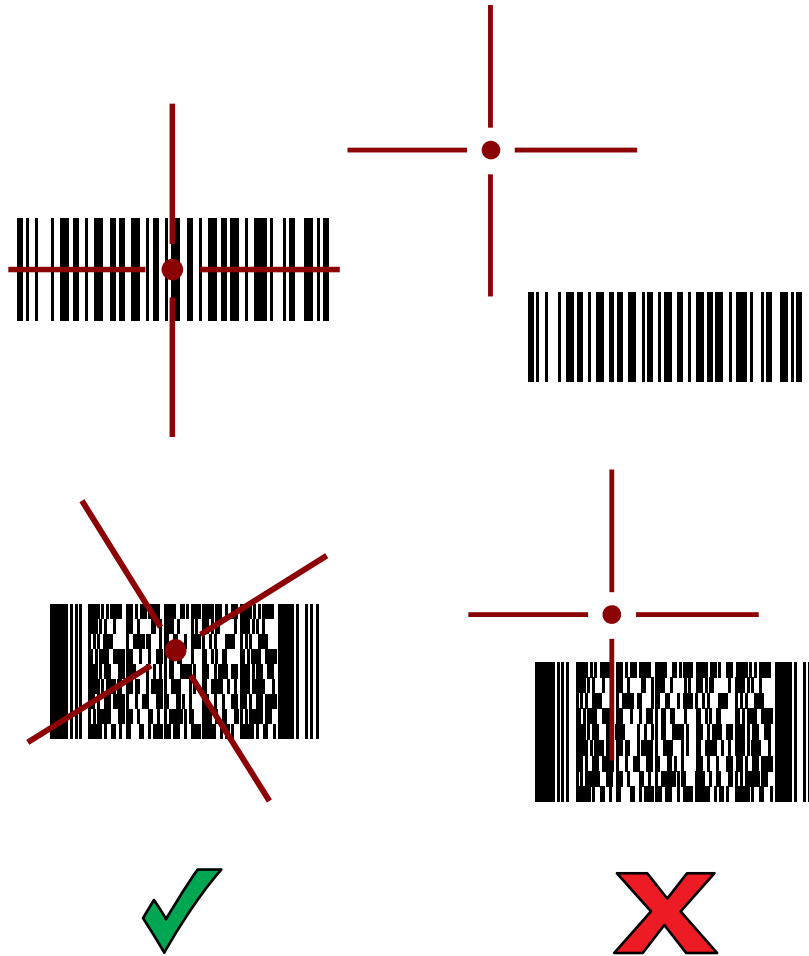
The red laser aiming pattern turns on to assist in aiming.



**NOTE:** When the device is in Pick List Mode, the device does not decode the barcode until the center of the aiming dot touches the barcode.

4. Ensure the barcode is within the area formed by the cross-hairs in the aiming pattern. The aiming dot is used for increased visibility in bright lighting conditions.

**Figure 12** Aiming Pattern: Standard Range





**NOTE:** When the device is in Pick List Mode, the device does not decode the barcode until the center of the crosshair touches the barcode.

**Figure 13** Pick List Mode with Multiple Barcodes - Standard Range



The Data Capture LED light green and a beep sounds, by default, to indicate the barcode was decoded successfully.

The Decode LED light green and a beep sounds, by default, to indicate the barcode was decoded successfully.

5. Release the scan button.

The barcode content data appears in the text field.



**NOTE:** Imager decoding usually occurs instantaneously. The device repeats the steps required to take a digital picture (image) of a poor or difficult barcode as long as the scan button remains pressed.

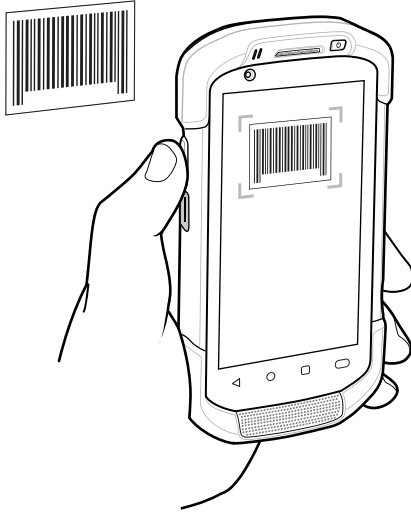
## Scanning with Internal Camera

Use the internal camera to capture barcode data.

When capturing barcode data in poor lighting, turn on Illumination mode in the DataWedge application.

1. Launch a scanning application.

2. Point the camera window at a barcode.



3. Press and hold the scan button.

By default, a preview window appears on the screen. The Decode light emitting diode (LED) lights red to indicate that data capture is in process.

4. Move the device until the barcode is visible on the screen.
5. If Picklist mode is enabled, move the device until the barcode is centered under the aiming dot on the screen.
6. The Decode LED lights green, a beep sounds and the device vibrates, by default, to indicate the barcode is decoded successfully.

The captured data appears in the text field.

## Scanning with the RS507/RS507X Hands-Free Imager

Use the RS507/RS507X Hands-Free Imager to capture barcode data.

**Figure 14** RS507/RS507X Hands-Free Imager



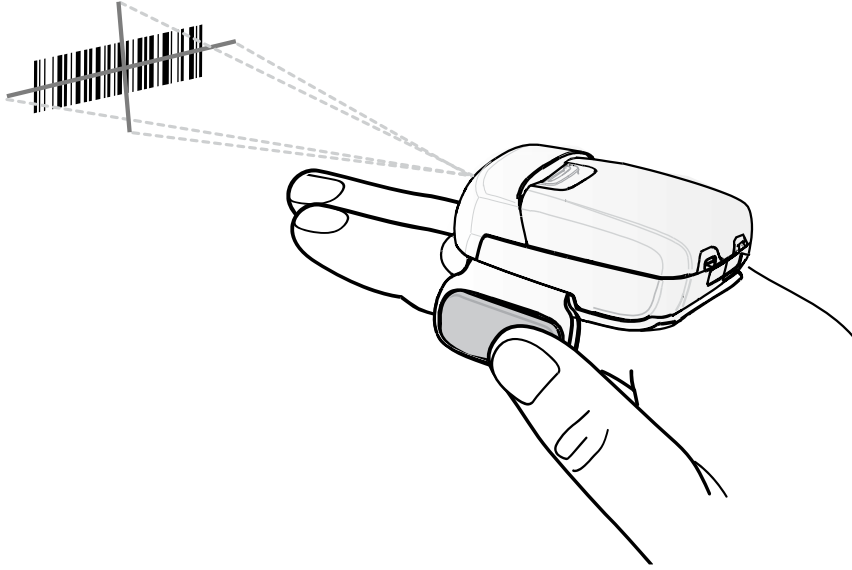
Refer to the RS507/RS507X Hands-free Imager Product Reference Guide for more information.



**NOTE:** To read a barcode, a scan-enabled app is required. The device contains the DataWedge app that allows the user to enable the scanner to decode barcode data and display the barcode content.

To scan with the RS507/RS507x:

1. Pair the RS507/RS507X with the device.
2. Ensure that an app is open on the device and a text field is in focus (text cursor in text field).
3. Point the RS507/RS507X at a barcode.

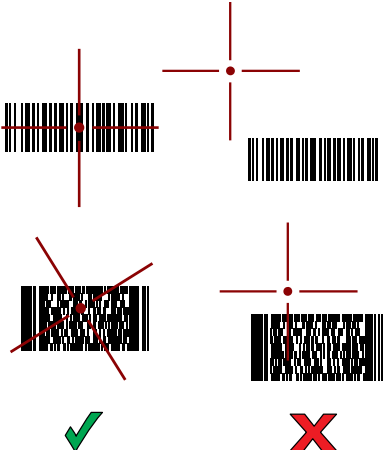




4. Press and hold the trigger.

The red laser aiming pattern turns on to assist in aiming. Ensure the barcode is within the area formed by the cross-hairs in the aiming pattern. The aiming dot increases visibility in bright lighting conditions.

Figure 15 RS507/RS507X Aiming Pattern



When the RS507/RS507X is in Pick List mode, the RS507/RS507X does not decode the barcode until the center of the crosshair touches the barcode.

Figure 16 RS507/RS507X Pick List Mode with Multiple Barcodes in Aiming Pattern



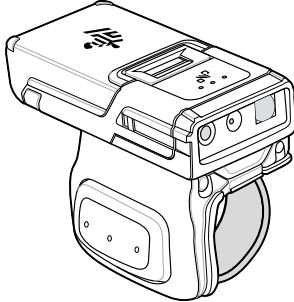
The RS507/RS507X LEDs light green and a beep sounds to indicate the barcode was decoded successfully.

The captured data appears in the text field.

## Scanning with the RS5100 Ring Scanner

Use the RS5100 Ring Scanner to capture barcode data.

**Figure 17** RS5100 Ring Scanner



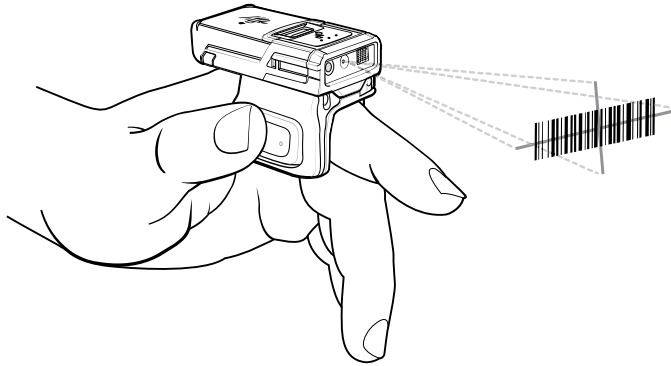
Refer to the RS5100 Ring Scanner Product Reference Guide for more information.



**NOTE:** To read a barcode, a scan-enabled app is required. The device contains the DataWedge app that allows the user to enable the scanner to decode barcode data and display the barcode content.

To scan with the RS5100:

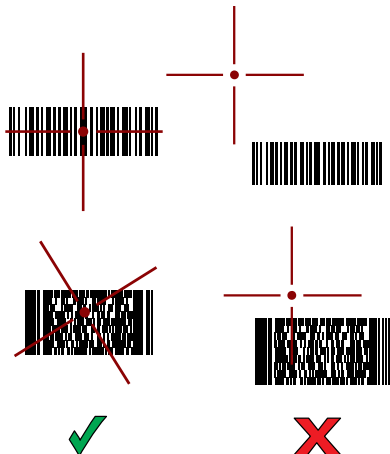
1. Pair the RS5100 with the device.
2. Ensure that an app is open on the device and a text field is in focus (text cursor in text field).
3. Point the RS5100 at a barcode.



4. Press and hold the trigger.

The red laser aiming pattern turns on to assist in aiming. Ensure the barcode is within the area formed by the cross-hairs in the aiming pattern. The aiming dot increases visibility in bright lighting conditions.

**Figure 18** RS5100 Aiming Pattern



When the RS5100 is in Pick List mode, the RS5100 does not decode the barcode until the center of the crosshair touches the barcode.

**Figure 19** RS5100 Pick List Mode with Multiple Barcodes in Aiming Pattern

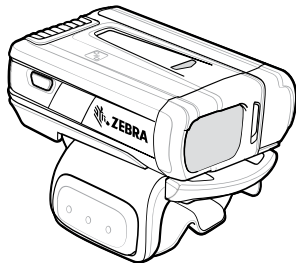


The RS5100 LEDs light green and a beep sounds to indicate the barcode was decoded successfully. The captured data appears in the text field.

## Scanning with the RS6000 Bluetooth Ring Scanner

Use the RS6000 Bluetooth Ring Scanner to capture barcode data.

**Figure 20** RS6000 Bluetooth Ring Scanner



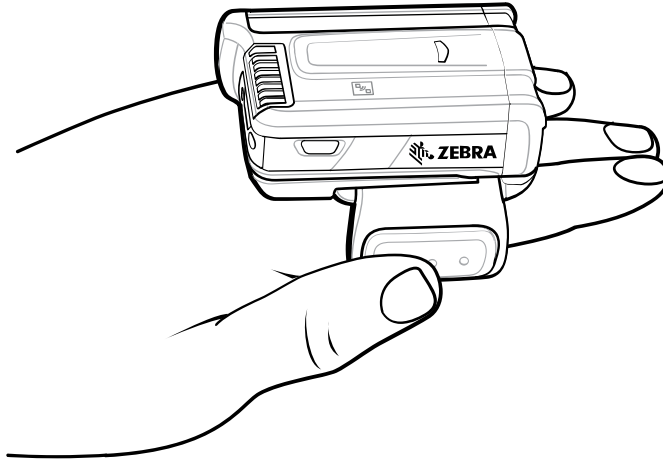
Refer to the RS6000 Bluetooth Ring Scanner Product Reference Guide for more information.



**NOTE:** To read a barcode, a scan-enabled app is required. The device contains the DataWedge app that allows the user to enable the scanner to decode barcode data and display the barcode content.

To scan with the RS6000:

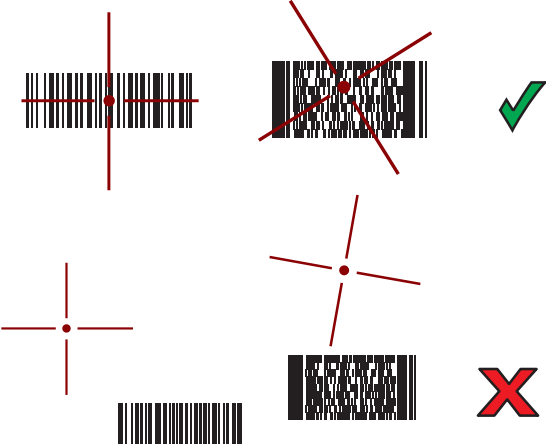
1. Pair the RS6000 with the device.
2. Ensure that an app is open on the device and a text field is in focus (text cursor in text field).
3. Point the RS6000 at a barcode.



4. Press and hold the trigger.

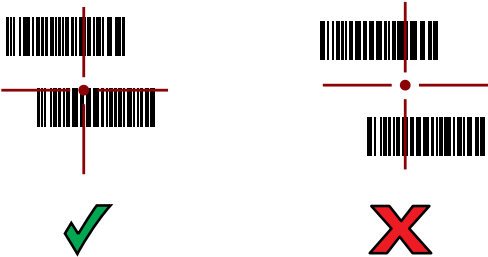
The red laser aiming pattern turns on to assist in aiming. Ensure the barcode is within the area formed by the cross-hairs in the aiming pattern. The aiming dot increases visibility in bright lighting conditions.

Figure 21 RS6000 Aiming Pattern



When the RS6000 is in Pick List mode, the RS6000 does not decode the barcode until the center of the crosshair touches the barcode.

Figure 22 RS6000 Pick List Mode with Multiple Barcodes in Aiming Pattern



The RS6000 LEDs light green and a beep sounds to indicate the barcode was decoded successfully. The captured data appears in the text field.

## Scanning with the DS2278 Digital Scanner

Use the DS2278 Digital Scanner to capture barcode data.

**Figure 23** DS2278 Digital Scanner



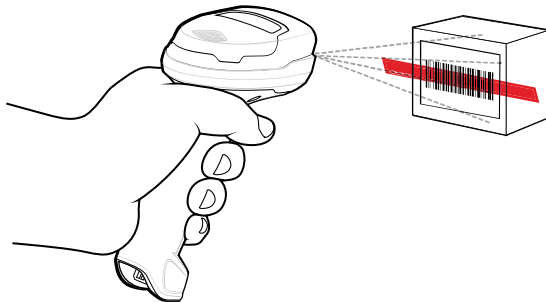
Refer to the DS2278 Digital Scanner Product Reference Guide for more information.



**NOTE:** To read a barcode, a scan-enabled app is required. The device contains the DataWedge app that allows the user to enable the scanner to decode barcode data and display the barcode content.

To scan with the DS2278:

1. Pair the DS2278 with the device. See [Pairing a Bluetooth Scanner](#) for more information.
2. Ensure that an app is open on the device and a text field is in focus (text cursor in text field).
3. Point the scanner at a barcode.



4. Press and hold the trigger.

5. Ensure the aiming pattern covers the barcode.



6. Upon successful decode, the scanner beeps and the LED flashes, and the scan line turns off. The captured data appears in the text field.

## Scanning with the DS3578 Bluetooth Scanner

Use the DS3678 Bluetooth Scanner to capture barcode data.

**Figure 24** DS3678 Digital Scanner



Refer to the DS3678 Product Reference Guide for more information.

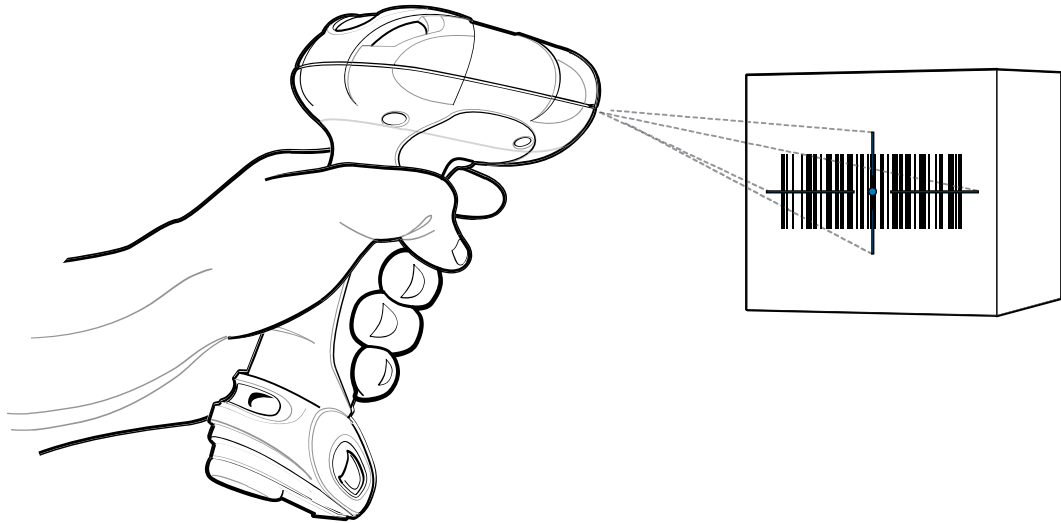


**NOTE:** To read a barcode, a scan-enabled app is required. The device contains the DataWedge app that allows the user to enable the scanner to decode barcode data and display the barcode content.

To scan with the DS3578 scanner:

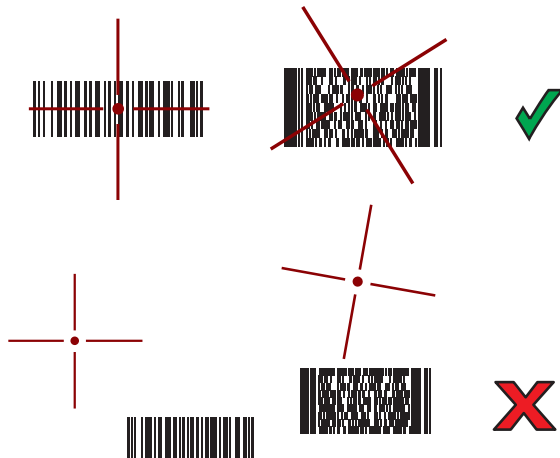
1. Pair the scanner with the device. See [Pairing Bluetooth Scanners](#) for more information.
2. Ensure that an app is open on the device and a text field is in focus (text cursor in text field).

3. Point the scanner at a barcode.



4. Press and hold the trigger.

Ensure the barcode is within the area formed by the aiming pattern. The aiming dot increases visibility in bright lighting conditions.



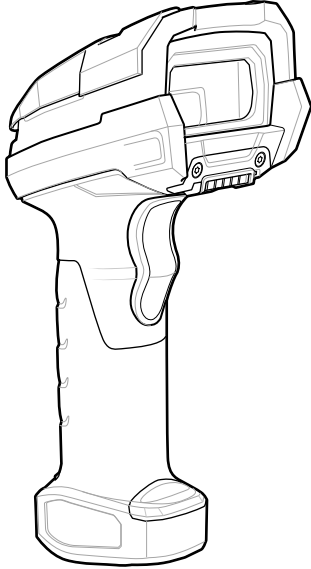
The captured data appears in the text field.



## Scanning with the DS3608 USB Scanner

Use the DS3608 Bluetooth Scanner to capture barcode data.

**Figure 25** DS3608 Digital Scanner



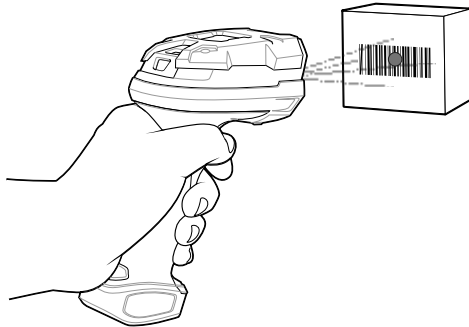
Refer to the DS3608 Product Reference Guide for more information.



**NOTE:** To read a barcode, a scan-enabled app is required. The device contains the DataWedge app that allows the user to enable the scanner to decode barcode data and display the barcode content.

To scan with the DS3678 scanner:

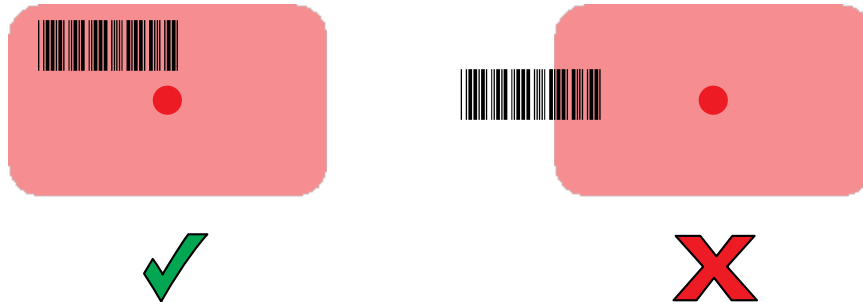
1. Connect the USB scanner to the device.
2. Ensure that an app is open on the device and a text field is in focus (text cursor in text field).
3. Point the scanner at a barcode.



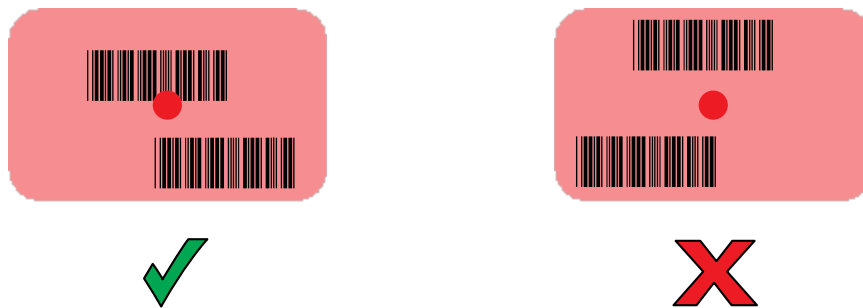
4. Press and hold the trigger.

Ensure the barcode is within the area formed by the aiming pattern. The aiming dot increases visibility in bright lighting conditions.

**Figure 26** DS3608 Aiming Pattern



**Figure 27** DS3608 Pick List Mode with Multiple Barcodes in Aiming Pattern

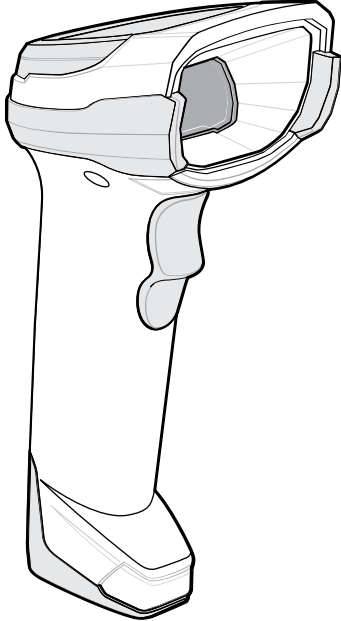


The captured data appears in the text field.

## Scanning with the DS8178 Digital Scanner

Use the DS8178 Bluetooth Scanner to capture barcode data.

**Figure 28** DS8178 Digital Scanner



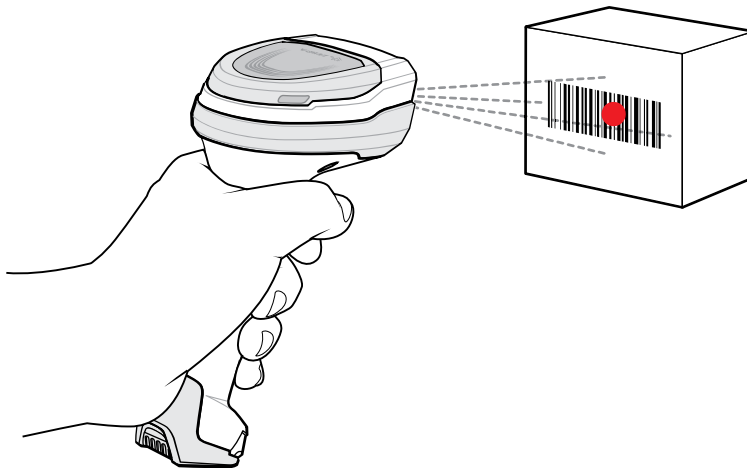
Refer to the DS8178 Digital Scanner Product Reference Guide for more information.



**NOTE:** To read a barcode, a scan-enabled app is required. The device contains the DataWedge app that allows the user to enable the scanner to decode barcode data and display the barcode content.

To scan with the DS8178 scanner:

1. Pair the scanner with the device. See [Pairing Bluetooth Scanners](#) for more information.
2. Ensure that an app is open on the device and a text field is in focus (text cursor in text field).
3. Point the scanner at a barcode.



4. Press and hold the trigger.

5. Ensure the barcode is within the area formed by the aiming pattern. The aiming dot increases visibility in bright lighting conditions.

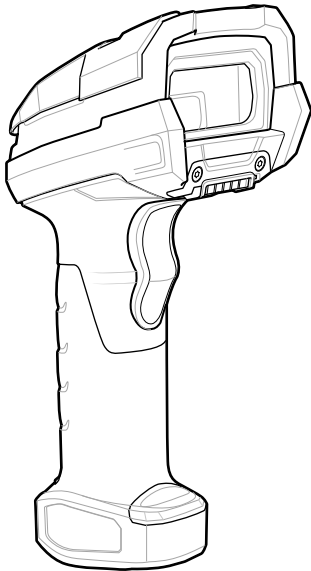


6. Upon successful decode, the scanner beeps and the LED flashes, and the scan line turns off. The captured data appears in the text field.

## Scanning with the LI3678 Linear Imager

Use the LI3678 linear imager to capture barcode data.

**Figure 29** LI3678 Bluetooth Scanner



Refer to the LI3678 Product Reference Guide for more information.

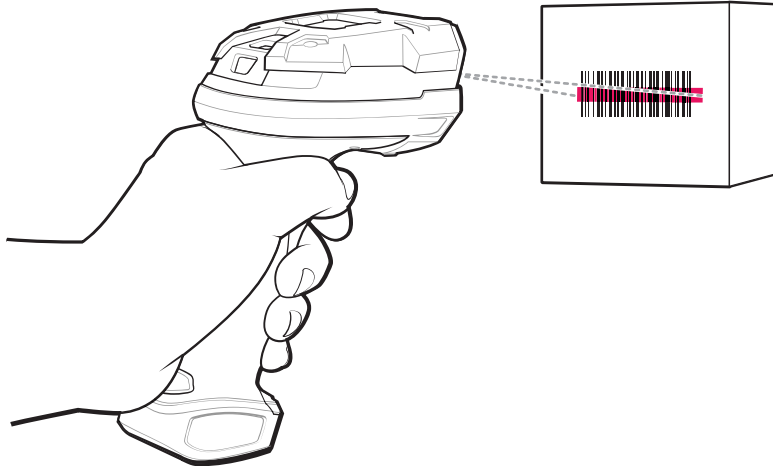


**NOTE:** To read a barcode, a scan-enabled app is required. The device contains the DataWedge app that allows the user to enable the scanner to decode barcode data and display the barcode content.

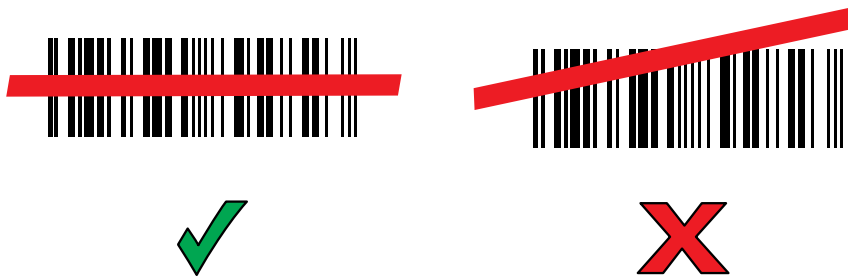
To scan with the LI3678:

1. Pair the LI3678 with the device. See [Pairing a Bluetooth Scanner](#) for more information.
2. Ensure that an app is open on the device and a text field is in focus (text cursor in text field).
3. Point the LI3678 at a barcode.

4. Press and hold the trigger.



5. Ensure the aiming pattern covers the barcode.

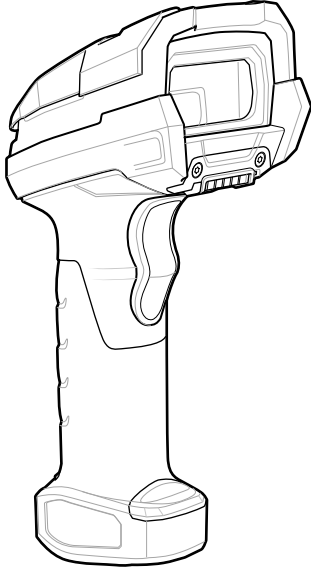


Upon successful decode, the scanner beeps and the LED displays a single green flash.  
The captured data appears in the text field.

## Scanning with the DS3678 Bluetooth Scanner

Use the DS3678 Bluetooth Scanner to capture barcode data.

**Figure 30** DS3678 Digital Scanner



Refer to the DS3678 Product Reference Guide for more information.

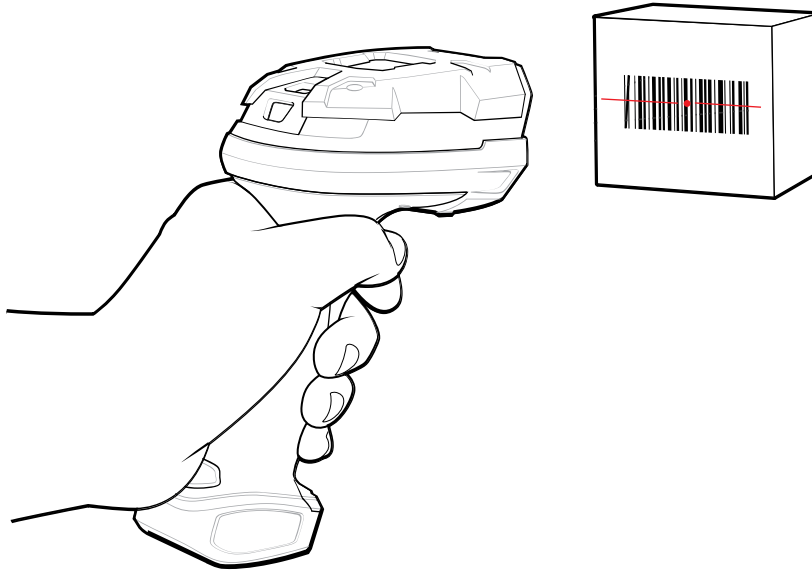


**NOTE:** To read a barcode, a scan-enabled app is required. The device contains the DataWedge app that allows the user to enable the scanner to decode barcode data and display the barcode content.

To scan with the DS3678 scanner:

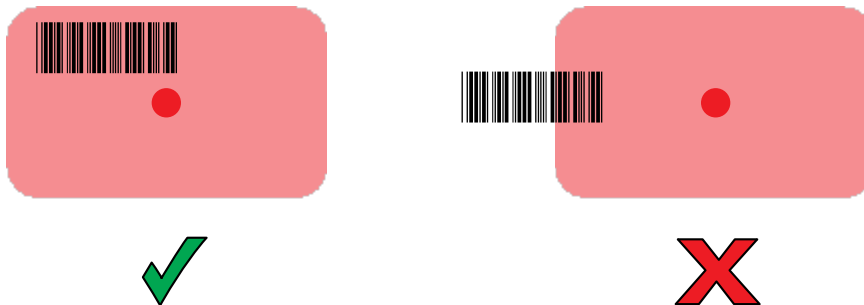
1. Pair the scanner with the device. See [Pairing Bluetooth Scanners](#) for more information.
2. Ensure that an app is open on the device and a text field is in focus (text cursor in text field).

3. Point the scanner at a barcode.



4. Press and hold the trigger.

Ensure the barcode is within the area formed by the aiming pattern. The aiming dot increases visibility in bright lighting conditions.



The captured data appears in the text field.

## Pairing a Bluetooth Ring Scanner

Before using a Bluetooth Ring Scanner with the device, connect the device to the Ring Scanner.

To connect the Ring Scanner to the device, use one of the following methods:

- Near Field Communication (NFC) (RS6000 only)
- Simple Serial Interface (SSI)
- Bluetooth Human Interface Device (HID) Mode.

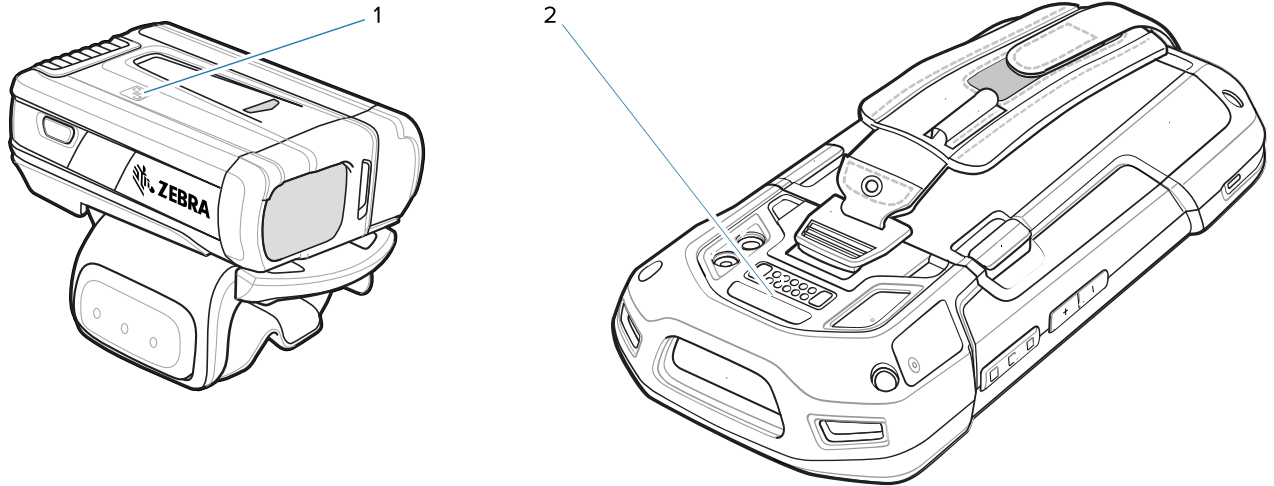
### Pairing in SSI Mode Using Near Field Communication

The device provides the ability to pair the RS5100 or RS6000 Ring Scanner in SSI Mode using NFC.



**NOTE:** RS6000 Only.


1. Ensure that the RS6000 is in SSI mode. Refer to the RS6000 User Guide for more information.
2. Ensure that NFC is enabled on the device.
3. Align the NFC icon on the Ring Scanner with the NFC icon on the back of the device.



1	NFC logo
2	NFC Antenna Area


The Status LED blinks blue indicating that the Ring Scanner is attempting to establish a connection with the device. When a connection is established, the Status LED turns off and the Ring Scanner emits a single string of low/high beeps.

A notification appears on the device screen.

The  icon appears in the Status bar.

## Pairing Using Simple Serial Interface (SSI)

Pair the Ring Scanner to the device using Simple Serial Interface.

1. Swipe up from the bottom of the Home screen and touch .
2. Using the Ring Scanner, scan the barcode on the screen.

The Ring Scanner emits a string of high/low/high/low beeps. The Scan LED flashes green indicating that the Ring Scanner is attempting to establish a connection with the device. When a connection is established, the Scan LED turns off and the Ring Scanner emits one string of low/high beeps.

A notification appears on the Notification panel and the  icon appears in the Status bar.

## Pairing Using Bluetooth Human Interface Device

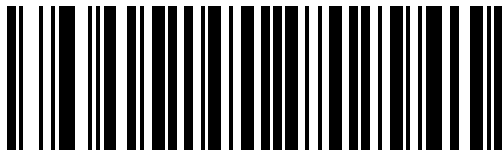
Pair the Ring Scanner to the device using Human Interface Device (HID).

1. Ensure that Bluetooth is enabled on both devices.
2. Ensure that the Bluetooth device to discover is in discoverable mode.
3. Ensure that the two devices are within 10 meters (32.8 feet) of one another.

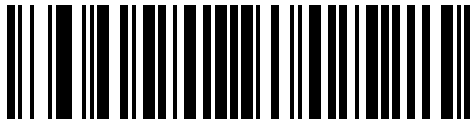



4. Place the Ring Scanner in HID mode. If the Ring Scanner is already in HID mode, skip to step 5.
  - a) Remove the battery from the Ring Scanner.
  - b) Press and hold **Restore**.
  - c) Install the battery onto the Ring Scanner.
  - d) Keep holding the Restore key for about five seconds until a chirp is heard and the Scan LEDs flash green.
  - e) Scan the barcode below to place the Ring Scanner in HID mode.

**Figure 31** RS507 Bluetooth HID Barcode



**Figure 32** RS6000 Bluetooth HID Barcode



5. Remove the battery from the Ring Scanner.
6. Re-install the battery into the Ring Scanner.
7. Swipe down from the Status bar to open the Quick Access panel and then touch .
8. Touch **Bluetooth**.
9. Touch **Pair new device**. The device begins searching for discoverable Bluetooth devices in the area and displays them under **Available devices**.
10. Scroll through the list and select Ring Scanner.

The device connects to the Ring Scanner and **Connected** appears below the device name. The Bluetooth device is added to the **Paired devices** list and a trusted (“paired”) connection is established.

A notification appears on the Notification panel and the  icon appears in the Status bar.

## Pairing a Bluetooth Scanner

Before using a Bluetooth scanner with the device, connect the device to the Bluetooth scanner.


Connect the scanner to the device using one of the following methods:

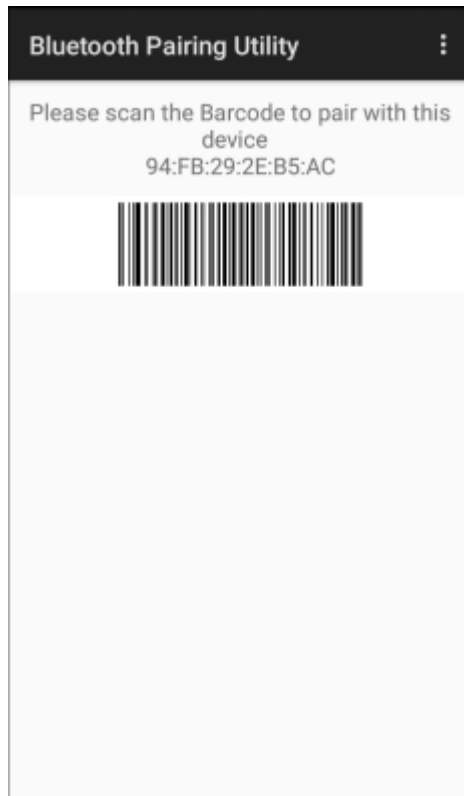
- Simple Serial Interface (SSI) mode
- Bluetooth Human Interface Device (HID) mode

### Pairing Using Simple Serial Interface

Pair the Ring Scanner to the device using Simple Serial Interface.


1. Ensure that the two devices are within 10 meters (32.8 feet) of one another.

2. Install the battery into the scanner.
3. Swipe up from the bottom of the Home screen and touch .



4. Using the Ring Scanner, scan the barcode on the screen.

The Ring Scanner emits a string of high/low/high/low beeps. The Scan LED flashes green indicating that the Ring Scanner is attempting to establish a connection with the device. When a connection is established, the Scan LED turns off and the Ring Scanner emits one string of low/high beeps.

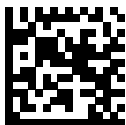
A notification appears on the Notification panel and the  icon appears in the Status bar.


## Pairing Using Bluetooth Human Interface Device

Pair the Bluetooth scanner to the device using HID.

To pair the scanner with the device using HID:

1. Remove the battery from the scanner.
2. Replace the battery.
3. After the scanner reboots, scan the barcode below to place the scanner in HID mode.



4. On the device, swipe down from the Status bar to open the Quick Access panel and then touch .
5. Touch **Bluetooth**.

6. Touch **Pair new device**. The device begins searching for discoverable Bluetooth devices in the area and displays them under **Available devices**.
7. Scroll through the list and select XXXXX xxxxxx, where XXXXX is the scanner and xxxxxx is the serial number.

The device connects to the scanner, the scanner beeps once and **Connected** appears below the device name. The Bluetooth device is added to the **Paired devices** list and a trusted (“paired”) connection is established.

## DataWedge

DataWedge is a utility that adds advanced barcode scanning capability to any application without writing code. It runs in the background and handles the interface to built-in barcode scanners. The captured barcode data is converted to keystrokes and sent to the target application as if it was typed on the keypad.

DataWedge allows any app on the device to get data from input sources such as a barcode scanner, MSR, RFID, voice, or serial port and manipulate the data based on options or rules.



Configure DataWedge to:

- Provide data capture services from any app.
- Use a particular scanner, reader, or other peripheral devices.
- Properly format and transmit data to a specific app.

To configure DataWedge, refer to [techdocs.zebra.com/datawedge/](http://techdocs.zebra.com/datawedge/).

## Enabling DataWedge



This procedure provides information on how to enable DataWedge on the device.

1. Swipe up from the bottom of the Home screen and touch .
2. Touch  > **Settings**.
3. Touch the **DataWedge enabled** checkbox.

A blue checkmark appears in the checkbox indicating that DataWedge is enabled.

## Disabling DataWedge

This procedure provides information on how to disable DataWedge on the device.

1. Swipe up from the bottom of the Home screen and touch .
2. Touch .
3. Touch **Settings**.
4. Touch **DataWedge enabled**.

## Supported Devices

This sections provides the supported decoders for each data capture option.

### Camera Supported Decoders

Lists the supported decoders for the internal camera.

**Table 11** Camera Supported Decoders

Decoder	Default State	Decoder	Default State	Decoder	Default State
Australian Postal	O	EAN8	X	MSI	O
Aztec	X	Grid Matrix	O	PDF417	X
Canadian Postal	O	GS1 DataBar	X	QR Code	X
Chinese 2 of 5	O	GS1 DataBar Expanded	X	Decoder Signature	O
Codabar	X	GS1 DataBar Limited	O	TLC 39	O
Code 11	O	GS1 Datamatrix	O	Trioptic 39	O
Code 128	X	GS1 QRCode	O	UK Postal	O
Code 39	X	HAN XIN	O	UPCA	X
Code 93	O	Interleaved 2 of 5	O	UPCE0	X
Composite AB	O	Japanese Postal	O	UPCE1	O
Composite C	O	Korean 3 of 5	O	US4state	O
Discrete 2 of 5	O	MAIL MARK	X	US4state FICS	O
Datamatrix	X	Matrix 2 of 5	O	US Planet	O
Dutch Postal	O	Maxicode	X	US Postnet	O
DotCode	X	MicroPDF	O		
EAN13	X	MicroQR	O		

Key: X = Enabled, O = Disabled, - = Not Supported

### SE4750-SR and SE4750-MR Internal Imager Supported Decoders

Lists the supported decoders for the SE4750-SR and SE4750-MR internal imager.

**Table 12** SE4750-SR and SE4750-MR Internal Imager Supported Decoders

Decoder	Default State	Decoder	Default State	Decoder	Default State
Australian Postal	O	EAN8	X	MSI	O

**Table 12** SE4750-SR and SE4750-MR Internal Imager Supported Decoders (Continued)

Decoder	Default State	Decoder	Default State	Decoder	Default State
Aztec	X	Grid Matrix	O	PDF417	X
Canadian Postal	O	GS1 DataBar	X	QR Code	X
Chinese 2 of 5	O	GS1 DataBar Expanded	X	Decoder Signature	O
Codabar	X	GS1 DataBar Limited	O	TLC 39	O
Code 11	O	GS1 Datamatrix	O	Trioptic 39	O
Code 128	X	GS1 QRCode	O	UK Postal	O
Code 39	X	HAN XIN	O	UPCA	X
Code 93	O	Interleaved 2 of 5	O	UPCE0	X
Composite AB	O	Japanese Postal	O	UPCE1	O
Composite C	O	Korean 3 of 5	O	US4state	O
Discrete 2 of 5	O	MAIL MARK	X	US4state FICS	O
Datamatrix	X	Matrix 2 of 5	O	US Planet	O
Dutch Postal	O	Maxicode	X	US Postnet	O
DotCode	X	MicroPDF	O		
EAN13	X	MicroQR	O		

Key: X = Enabled, O = Disabled, — = Not Supported

## SE4770 Internal Imager Supported Decoders

Lists the supported decoders for the SE4770 internal imager.

**Table 13** SE4770 Internal Imager Supported Decoders

Decoder	Default State	Decoder	Default State	Decoder	Default State
Australian Postal	O	EAN8	X	MSI	O
Aztec	X	Grid Matrix	O	PDF417	X
Canadian Postal	O	GS1 DataBar	X	QR Code	X
Chinese 2 of 5	O	GS1 DataBar Expanded	X	Decoder Signature	O
Codabar	X	GS1 DataBar Limited	O	TLC 39	O
Code 11	O	GS1 Datamatrix	O	Trioptic 39	O

**Table 13** SE4770 Internal Imager Supported Decoders (Continued)

Decoder	Default State	Decoder	Default State	Decoder	Default State
Code 128	X	GS1 QRCode	O	UK Postal	O
Code 39	X	HAN XIN	O	UPCA	X
Code 93	O	Interleaved 2 of 5	O	UPCE0	X
Composite AB	O	Japanese Postal	O	UPCE1	O
Composite C	O	Korean 3 of 5	O	US4state	O
Discrete 2 of 5	O	MAIL MARK	X	US4state FICS	O
Datamatrix	X	Matrix 2 of 5	O	US Planet	O
Dutch Postal	O	Maxicode	X	US Postnet	O
DotCode	O	MicroPDF	O		
EAN13	X	MicroQR	O		

Key: X = Enabled, O = Disabled, - = Not Supported

## RS507/RS507x Supported Decoders

Lists the supported decoders for the RS507/RS507x Ring Scanner.

**Table 14** RS507/RS507x Supported Decoders

Decoder	Default State	Decoder	Default State	Decoder	Default State
Australian Postal	O	EAN8	X	MSI	O
Aztec	X	Grid Matrix	O	PDF417	X
Canadian Postal	-	GS1 DataBar	X	QR Code	X
Chinese 2 of 5	O	GS1 DataBar Expanded	X	Decoder Signature	O
Codabar	X	GS1 DataBar Limited	O	TLC 39	O
Code 11	O	GS1 Datamatrix	-	Trioptic 39	O
Code 128	X	GS1 QRCode	-	UK Postal	O
Code 39	O	HAN XIN	-	UPCA	X
Code 93	O	Interleaved 2 of 5	O	UPCE0	X
Composite AB	O	Japanese Postal	O	UPCE1	O
Composite C	O	Korean 3 of 5	O	US4state	O
Discrete 2 of 5	O	MAIL MARK	-	US4state FICS	O

**Table 14** RS507/RS507x Supported Decoders (Continued)

Decoder	Default State	Decoder	Default State	Decoder	Default State
Datamatrix	X	Matrix 2 of 5	O	US Planet	O
Dutch Postal	O	Maxicode	X	US Postnet	O
DotCode	O	MicroPDF	O		
EAN13	X	MicroQR	O		

Key: X = Enabled, O = Disabled, - = Not Supported

## RS5100 Supported Decoders

Lists the supported decoders for the RS5100 Ring Scanner.

**Table 15** RS5100 Supported Decoders

Decoder	Default State	Decoder	Default State	Decoder	Default State
Australian Postal	O	EAN8	X	MSI	O
Aztec	X	Grid Matrix	O	PDF417	X
Canadian Postal	O	GS1 DataBar	X	QR Code	X
Chinese 2 of 5	O	GS1 DataBar Expanded	X	Decoder Signature	O
Codabar	X	GS1 DataBar Limited	O	TLC 39	O
Code 11	O	GS1 Datamatrix	O	Trioptic 39	O
Code 128	X	GS1 QRCode	O	UK Postal	O
Code 39	X	HAN XIN	O	UPCA	X
Code 93	O	Interleaved 2 of 5	O	UPCE0	X
Composite AB	O	Japanese Postal	O	UPCE1	O
Composite C	O	Korean 3 of 5	O	US4state	O
Discrete 2 of 5	O	MAIL MARK	X	US4state FICS	O
Datamatrix	X	Matrix 2 of 5	O	US Planet	O
Dutch Postal	O	Maxicode	X	US Postnet	O
DotCode	O	MicroPDF	O		
EAN13	X	MicroQR	O		

Key: X = Enabled, O = Disabled, - = Not Supported

## RS6000 Supported Decoders

Lists the supported decoders for the RS6000 Ring Scanner.

**Table 16** RS6000 Supported Decoders

Decoder	Default State	Decoder	Default State	Decoder	Default State
Australian Postal	O	EAN8	X	MSI	O
Aztec	X	Grid Matrix	O	PDF417	X
Canadian Postal	O	GS1 DataBar	X	QR Code	X
Chinese 2 of 5	O	GS1 DataBar Expanded	X	Decoder Signature	O
Codabar	X	GS1 DataBar Limited	O	TLC 39	O
Code 11	O	GS1 Datamatrix	O	Trioptic 39	O
Code 128	X	GS1 QRCode	O	UK Postal	O
Code 39	X	HAN XIN	O	UPCA	X
Code 93	O	Interleaved 2 of 5	O	UPCE0	X
Composite AB	O	Japanese Postal	O	UPCE1	O
Composite C	O	Korean 3 of 5	O	US4state	O
Discrete 2 of 5	O	MAIL MARK	X	US4state FICS	O
Datamatrix	X	Matrix 2 of 5	O	US Planet	O
Dutch Postal	O	Maxicode	X	US Postnet	O
DotCode	O	MicroPDF	O		
EAN13	X	MicroQR	O		

Key: X = Enabled, O = Disabled, - = Not Supported

## DS2278 Supported Decoders

Lists the supported decoders for the DS2278 Digital Scanner.

**Table 17** DS2278 Digital Scanner Supported Decoders

Decoder	Default State	Decoder	Default State	Decoder	Default State
Australian Postal	O	EAN8	X	MSI	O
Aztec	X	Grid Matrix	O	PDF417	X
Canadian Postal	—	GS1 DataBar	X	QR Code	X



**Table 17** DS2278 Digital Scanner Supported Decoders (Continued)

Decoder	Default State	Decoder	Default State	Decoder	Default State
Chinese 2 of 5	O	GS1 DataBar Expanded	X	Decoder Signature	O
Codabar	X	GS1 DataBar Limited	O	TLC 39	O
Code 11	O	GS1 Datamatrix	O	Trioptic 39	O
Code 128	X	GS1 QRCode	O	UK Postal	O
Code 39	X	HAN XIN	—	UPCA	X
Code 93	O	Interleaved 2 of 5	O	UPCE0	X
Composite AB	O	Japanese Postal	O	UPCE1	O
Composite C	O	Korean 3 of 5	O	US4state	O
Discrete 2 of 5	O	MAIL MARK	X	US4state FICS	O
Datamatrix	X	Matrix 2 of 5	O	US Planet	O
Dutch Postal	O	Maxicode	X	US Postnet	O
DotCode	O	MicroPDF	O		
EAN13	X	MicroQR	O		

Key: X = Enabled, O = Disabled, — = Not Supported

## DS3578 Supported Decoders

Lists the supported decoders for the DS3578 Digital Scanner.

**Table 18** DS3578 Digital Scanner Supported Decoders

Decoder	Default State	Decoder	Default State	Decoder	Default State
Australian Postal	O	EAN8	X	MSI	O
Aztec	X	Grid Matrix	O	PDF417	X
Canadian Postal	—	GS1 DataBar	X	QR Code	X
Chinese 2 of 5	O	GS1 DataBar Expanded	X	Decoder Signature	—
Codabar	X	GS1 DataBar Limited	O	TLC 39	O
Code 11	O	GS1 Datamatrix	O	Trioptic 39	O
Code 128	X	GS1 QRCode	O	UK Postal	O
Code 39	X	HAN XIN	—	UPCA	X

**Table 18** DS3578 Digital Scanner Supported Decoders (Continued)

Decoder	Default State	Decoder	Default State	Decoder	Default State
Code 93	O	Interleaved 2 of 5	O	UPCE0	X
Composite AB	O	Japanese Postal	O	UPCE1	O
Composite C	O	Korean 3 of 5	O	US4state	O
Discrete 2 of 5	O	MAIL MARK	X	US4state FICS	O
Datamatrix	X	Matrix 2 of 5	O	US Planet	O
Dutch Postal	O	Maxicode	X	US Postnet	O
DotCode	O	MicroPDF	O		
EAN13	X	MicroQR	O		

Key: X = Enabled, O = Disabled, — = Not Supported

## DS3608 Supported Decoders

Lists the supported decoders for the DS3608 scanner.

**Table 19** DS3608 Supported Decoders

Decoder	Default State	Decoder	Default State	Decoder	Default State
Australian Postal	O	EAN8	X	MSI	O
Aztec	X	Grid Matrix	O	PDF417	X
Canadian Postal	—	GS1 DataBar	X	QR Code	X
Chinese 2 of 5	O	GS1 DataBar Expanded	X	Decoder Signature	—
Codabar	X	GS1 DataBar Limited	O	TLC 39	O
Code 11	O	GS1 Datamatrix	O	Trioptic 39	O
Code 128	X	GS1 QRCode	O	UK Postal	O
Code 39	X	HAN XIN	O	UPCA	X
Code 93	O	Interleaved 2 of 5	O	UPCE0	X
Composite AB	O	Japanese Postal	O	UPCE1	O
Composite C	O	Korean 3 of 5	O	US4state	O
Discrete 2 of 5	O	MAIL MARK	X	US4state FICS	O
Datamatrix	X	Matrix 2 of 5	O	US Planet	O
Dutch Postal	O	Maxicode	X	US Postnet	O

**Table 19** DS3608 Supported Decoders (Continued)

Decoder	Default State	Decoder	Default State	Decoder	Default State
DotCode	O	MicroPDF	O		
EAN13	X	MicroQR	O		

Key: X = Enabled, O = Disabled, — = Not Supported

## DS3678 Supported Decoders

Lists the supported decoders for the DS3678 scanner.

**Table 20** DS3678 Supported Decoders

Decoder	Default State	Decoder	Default State	Decoder	Default State
Australian Postal	O	EAN8	X	MSI	O
Aztec	X	Grid Matrix	O	PDF417	X
Canadian Postal	—	GS1 DataBar	X	QR Code	X
Chinese 2 of 5	O	GS1 DataBar Expanded	X	Decoder Signature	—
Codabar	X	GS1 DataBar Limited	O	TLC 39	O
Code 11	O	GS1 Datamatrix	O	Trioptic 39	O
Code 128	X	GS1 QRCode	O	UK Postal	O
Code 39	X	HAN XIN	O	UPCA	X
Code 93	O	Interleaved 2 of 5	O	UPCE0	X
Composite AB	O	Japanese Postal	O	UPCE1	O
Composite C	O	Korean 3 of 5	O	US4state	O
Discrete 2 of 5	O	MAIL MARK	X	US4state FICS	O
Datamatrix	X	Matrix 2 of 5	O	US Planet	O
Dutch Postal	O	Maxicode	X	US Postnet	O
DotCode	O	MicroPDF	O		
EAN13	X	MicroQR	O		

Key: X = Enabled, O = Disabled, — = Not Supported

## DS8178 Supported Decoders

Lists the supported decoders for the DS8178 Digital scanner.

**Table 21** DS8178 Digital Scanner Supported Decoders

Decoder	Default State	Decoder	Default State	Decoder	Default State
Australian Postal	O	EAN8	X	MSI	O
Aztec	X	Grid Matrix	O	PDF417	X
Canadian Postal	—	GS1 DataBar	X	QR Code	X
Chinese 2 of 5	O	GS1 DataBar Expanded	X	Decoder Signature	—
Codabar	X	GS1 DataBar Limited	O	TLC 39	O
Code 11	O	GS1 Datamatrix	O	Trioptic 39	O
Code 128	X	GS1 QRCode	O	UK Postal	O
Code 39	X	HAN XIN	—	UPCA	X
Code 93	O	Interleaved 2 of 5	O	UPCE0	X
Composite AB	O	Japanese Postal	O	UPCE1	O
Composite C	O	Korean 3 of 5	O	US4state	O
Discrete 2 of 5	O	MAIL MARK	X	US4state FICS	O
Datamatrix	X	Matrix 2 of 5	O	US Planet	O
Dutch Postal	O	Maxicode	X	US Postnet	O
DotCode	O	MicroPDF	O		
EAN13	X	MicroQR	O		

Key: X = Enabled, O = Disabled, — = Not Supported

## LI3678 Supported Decoders

Lists the supported decoders for the LI3678 scanner.

**Table 22** LI3678 Supported Decoders

Decoder	Default State	Decoder	Default State	Decoder	Default State
Australian Postal	—	EAN8	X	MSI	O
Aztec	—	Grid Matrix	O	PDF417	—
Canadian Postal	—	GS1 DataBar	X	QR Code	—

**Table 22** LI3678 Supported Decoders (Continued)

Decoder	Default State	Decoder	Default State	Decoder	Default State
Chinese 2 of 5	O	GS1 DataBar Expanded	X	Decoder Signature	—
Codabar	X	GS1 DataBar Limited	O	TLC 39	O
Code 11	O	GS1 Datamatrix	—	Trioptic 39	O
Code 128	X	GS1 QRCode	—	UK Postal	—
Code 39	X	HAN XIN	O	UPCA	X
Code 93	O	Interleaved 2 of 5	O	UPCE0	X
Composite AB	—	Japanese Postal	—	UPCE1	O
Composite C	—	Korean 3 of 5	O	US4state	—
Discrete 2 of 5	O	MAIL MARK	—	US4state FICS	—
Datamatrix	—	Matrix 2 of 5	O	US Planet	—
Dutch Postal	—	Maxicode	—	US Postnet	—
DotCode	O	MicroPDF	—		
EAN13	X	MicroQR	—		

Key: X = Enabled, O = Disabled, — = Not Supported

# Wireless

This section provides information on the wireless features of the device

The following wireless features are available on the device:

- Wireless Wide Area Network (WWAN)
- Wireless Local Area Network (WLAN)
- Bluetooth
- Cast
- Near Field Communications (NFC)

## Wireless Wide Area Networks

Use Wireless wide area networks (WWANs) to access data over a cellular network.



**NOTE:** TC77 only.

This section provides information on:

- Sharing a data connection
- Monitoring data usage
- Changing Cellular Network settings

## Sharing the Mobile Data Connection

The **Tethering & Portable Hotspot** settings allow sharing the mobile data connection with a single computer via USB tethering or Bluetooth tethering.

Share the data connection with up to eight devices at once, by turning it into a portable Wi-Fi hotspot. While the device is sharing its data connection, an icon displays at the top of the screen and a corresponding message appears in the notification list.

### Enabling USB Tethering



**NOTE:** USB tethering is not supported on computers running Mac OS. If the computer is running Windows or a recent version of Linux (such as Ubuntu), follow these instructions without any special preparation. If running a version of Windows that precedes Windows 7, or some other

operating system, you may need to prepare the computer to establish a network connection via USB.

1. Connect the device to a host computer with a USB cable.

The notification **Charging this device via USB** appears in the Notifications panel.

2. Go to **Settings**.
3. Touch **Network & Internet**.
4. Touch **Hotspot & tethering**.
5. Touch the **USB tethering** switch to enable.

The host computer is now sharing the device's data connection.

To stop sharing the data connection, touch the **USB tethering** switch again or disconnect the USB cable.

### Enabling Bluetooth Tethering

Use Bluetooth tethering to share the data connection with a host computer.

Configure the host computer to obtain its network connection using Bluetooth. For more information, see the host computer's documentation.


1. Pair the device with the host computer.
2. Go to **Settings**.
3. Touch **Networking & Internet**.
4. Touch **Advanced**.
5. Touch **Hotspot & tethering**.
6. Touch the **Bluetooth tethering** switch to enable.

The host computer is now sharing the device's data connection.

To stop sharing the data connection, touch the **Bluetooth tethering** switch again.

### Enabling Wi-Fi Hotspot

1. Go to **Settings**.
2. Touch **Networking & Internet**.
3. Touch **Hotspot & tethering**.
4. Touch **Wi-Fi hotspot**.
5. Toggle the switch to enable.

After a moment, the device starts broadcasting its Wi-Fi network name (SSID). Connect to it with up to eight computers or other devices. The Hotspot  icon appears in the Status bar.

To stop sharing the data connection, touch the toggle switch again.

### Configuring the Wi-Fi Hotspot

1. Go to **Settings**.
2. Touch **Networking & Internet**.

3. Touch **Hotspot & tethering**.
4. Touch **Wi-Fi hotspot**.
5. In the **Hotspot** name text field, edit the name for the hotspot.
6. Touch **Security** and select a security method from the drop-down list.
  - **WPA3-Personal**
    - a. Touch **Hotspot password**.
    - b. Enter a password.
    - c. Touch **OK**.
  - **WPA2-Personal**
    - a. Touch **Hotspot password**.
    - b. Enter a password.
    - c. Touch **OK**.
  - **None** - If **None** is selected in the Security option, a password is not required.
7. Touch **Advanced**.
8. In the **AP Band** drop-down list, select **2.4 GHz Band** or **5.0 GHz Band**.
9. If desired, touch **Turn off hotspot automatically** to turn off Wi-Fi Hotspot when no devices are connected.

## Data Usage

Data usage refers to the amount of data uploaded or downloaded by the device during a given period. Depending on the wireless plan, you may be charged additional fees when your data usage exceeds your plan's limit.

Data usage settings allow:

- Enable Data Saver.
- Set the data usage warning level.
- Set a data usage limit.
- View or restrict data usage by app.
- Identify mobile hotspots and restrict background downloads that may result in extra charges.

## Monitoring Data Usage

1. Go to **Settings**.
2. Touch **Network & internet > Mobile network > Data usage**.




**CAUTION:** The usage displayed on the data usage settings screen is measured by your device. Your carrier's data usage accounting may differ. Usage in excess of your carrier plan's data limits can result in steep overage charges. The feature described here can help you track your usage, but is not guaranteed to prevent additional charges.

By default, the data usage settings screen displays the mobile data settings. That is, the data network or networks provided by your carrier.




## Setting Data Usage Warning

Set a warning alert when the device has used a certain amount of mobile data.

1. Go to **Settings**.
2. Touch **Network & internet > Mobile network > Data usage > **.
3. If necessary, touch **Set data warning** to enable it.
4. Touch **Data warning**.
5. Enter a number.  
To switch between megabytes (MB) and gigabytes (GB), touch the down arrow.
6. Touch **SET**.

When the data usage reaches the set level, a notification appears.

## Setting Data Limit

1. Go to **Settings**.
2. Touch **Network & internet > Mobile network > Data usage > **.
3. Touch **Set data limit**.
4. Touch **OK**.
5. Touch **Data limit**.
6. Enter a number.  
To switch between megabytes (MB) and gigabytes (GB), touch the down arrow.
7. Touch **Set**.

When the limit is reached, data automatically turns off and a notification appears.

## Cellular Network Settings

Cellular network settings applies to WWAN devices only.

### Data When Roaming

Roaming is disabled by default to prevent the device from transmitting data over other carriers' mobile networks when leaving an area that is covered by the carrier's networks. This is useful for controlling expenses if the service plan does not include data roaming.

### Setting Preferred Network Type

Change the network operating mode.

1. Go to **Settings**.
2. Touch **Network & Internet > Mobile network > Advanced > Preferred network type**.

3. In the **Preferred network type** dialog box, select a mode to set as default.
  - Automatic (LWG)
  - LTE only
  - 3G only
  - 2G only

### Setting Preferred Network

Change the network operating mode.

1. Go to **Settings**.
2. Touch **Network & Internet > Mobile network > Advanced**.
3. Touch **Automatically select network**.
4. Touch **Network**.
5. In the **Available network** list, select a carrier network.

### Using Search for MicroCell

A MicroCell acts like a mini cell tower in a building or residence and connects to an existing broadband Internet service. It improves cell signal performance for voice calls, texts, and cellular data applications like picture messaging and Web surfing.

1. Go to **Settings**.
2. Touch **Network & Internet > Mobile network**.
3. Touch **Search for MicroCell**.

### Configuring the Access Point Name

To use the data on a network, configure the APN information.



**NOTE:** Many service provider Access Point Name (APN) data are pre-configured in the device. The APN information for all other service providers must be obtained from the wireless service provider.

1. Go to **Settings**.
2. Touch **Network & Internet > Mobile network > Advanced**.
3. Touch **Access Point Names**.
4. Touch an APN name in the list to edit an existing APN or touch + to create a new APN.
5. Touch each APN setting and enter the appropriate data obtained from the wireless service provider.
6. When finished, touch **⋮ > Save**.
7. Touch the radio button next to the APN name to start using it.

## Locking the SIM Card

Locking the SIM card requires the user to enter a PIN every time the device is turned on. If the correct PIN is not entered, only emergency calls can be made.

1. Go to **Settings**.
2. Touch **Security > SIM card lock**.
3. Touch **Lock SIM card**.
4. Enter the PIN associated with the card.
5. Touch **OK**.
6. Reset the device.

## Wireless Local Area Networks

Wireless local area networks (WLANs) allow the device to communicate wirelessly inside a building. Before using the device on a WLAN, the facility must be set up with the required hardware to run the WLAN (sometimes known as infrastructure). The infrastructure and the device must both be properly configured to enable this communication.

Refer to the documentation provided with the infrastructure (access points (APs), access ports, switches, Radius servers, etc.) for instructions on how to set up the infrastructure.

Once the infrastructure is set up to enforce the chosen WLAN security scheme, use the **Wireless & networks** settings configure the device to match the security scheme.

The device supports the following WLAN security options:

- None
- Enhanced Open
- Wireless Equivalent Privacy (WEP)
- Wi-Fi Protected Access (WPA)/WPA2 Personal (PSK)
- WPA3-Personal
- WPA/WPA2/WPA3 Enterprise (EAP)
  - Protected Extensible Authentication Protocol (PEAP) - with MSCHAPV2 and GTC authentication.
  - Transport Layer Security (TLS)
  - Tunneled Transport Layer Security (TTLS) - with Password Authentication Protocol (PAP), MSCHAP and MSCHAPv2 authentication.
  - Password (PWD).
  - Extensible Authentication Protocol Method for Subscriber Identity Module (SIM)
  - Extensible Authentication Protocol Method for Authentication and Key Agreement (AKA)
  - Improved Extensible Authentication Protocol Method for Authentication and Key Agreement (AKA')
  - Lightweight Extensible Authentication Protocol (LEAP).
- WPA3-Enterprise 192-bit

The **Status** bar displays icons that indicate Wi-Fi network availability and Wi-Fi status.



**NOTE:** To extend the life of the battery, turn off Wi-Fi when not in use.

## Connecting to a Wi-Fi Network

1. Go to **Settings**.
2. Touch **Network & internet**.
3. Touch **Wi-Fi** to open the **Wi-Fi** screen. The device searches for WLANs in the area and lists them.
4. Scroll through the list and select the desired WLAN network.
5. For open networks, touch profile once or press and hold and then select **Connect** or for secure networks enter the required password or other credentials then touch **Connect**. See the system administrator for more information.

The device obtains a network address and other required information from the network using the dynamic host configuration protocol (DHCP) protocol. To configure the device with a fixed internet protocol (IP) address, see [Configuring the Device to Use a Static IP Address](#) on page 127.

6. In the Wi-Fi setting field, **Connected** appears indicating that the device is connected to the WLAN.

## Wi-Fi Version

When the device is connected to a Wi-Fi network, the Wi-Fi icon on the Status bar indicates the Wi-Fi network version.

**Table 23** Wi-Fi Version Icons

Icon	Description
	Connected to Wi-Fi 5, the 802.11ac standard.
	Connected to Wi-Fi 4, the 802.11n standard.

## Removing a Wi-Fi Network

Remove a remembered or connected Wi-Fi network.

1. Go to **Settings**.
2. Touch **Network & Internet > Wi-Fi**.
3. Scroll down to the bottom of the list and touch **Saved networks**.
4. Touch the name of the network.
5. Touch **FORGET**.

## WLAN Configuration

This section provides information on configuring Wi-Fi settings.

## Configuring a Secure Wi-Fi Network

1. Go to **Settings**.
2. Touch **Network & Internet > Wi-Fi**.
3. Slide the switch to the **ON** position.
4. The device searches for WLANs in the area and lists them on the screen.
5. Scroll through the list and select the desired WLAN network.
6. Touch the desired network. If network security is **Open**, the device automatically connects to the network. For all other network security, a dialog box appears.
7. If network security is **WPA/WPA2-Personal**, **WPA3-Personal**, or **WEP**, enter the required password and then touch **Connect**.
8. If network security is **WPA/WPA2/WPA3 Enterprise**:
  - a) Touch the **EAP method** drop-down list and select one of the following:
    - **PEAP**
    - **TLS**
    - **TTLS**
    - **PWD**
    - **SIM**
    - **AKA**
    - **AKA'**
    - **LEAP**
  - b) Fill in the appropriate information. Options vary depending on the **EAP method** chosen.
    - When selecting **CA certificate**, Certification Authority (CA) certificates are installed using the **Security** settings.
    - When using the EAP methods PEAP, TLS, or TTLS, specify a domain.
    - Touch **Advanced options** to display additional network options.
9. If the network security is **WPA3-Enterprise 192-bit**:
  - Touch **CA certificate** and select a Certification Authority (CA) certificate. Note: Certificates are installed using the Security settings.
  - Touch **User certificate** and select a user certificate. Note: User certificates are installed using the Security settings.
  - In the **Identity** text box, enter the username credentials.



**NOTE:** By default, the network Proxy is set to None and the IP settings is set to DHCP. See [Configuring for a Proxy Server](#) on page 127 for setting the connection to a proxy server and see [Configuring the Device to Use a Static IP Address](#) on page 127 for setting the device to use a static IP address.

10. Touch **Connect**.

## Manually Adding a Wi-Fi Network

1. Go to **Settings**.
2. Touch **Network & Internet > Wi-Fi**.
3. Slide the Wi-Fi switch to the **On** position.
4. Scroll to the bottom of the list and select **Add network**.
5. In the **Network name** text box, enter the name of the Wi-Fi network.
6. In the **Security** drop-down list, set the type of security to:
  - **None**
  - **Enhanced Open**
  - **WEP**
  - **WPA/WPA2-Personal**
  - **WPA3-Personal**
  - **WPA/WPA2/WPA3-Enterprise**
  - **WPA3-Enterprise 192-bit**
7. If the network security is **None** or **Enhanced Open**, touch **Save**.
8. If the network security is **WEP**, **WPA3-Personal**, or **WPA/WPA2-Personal**, enter the required password and then touch **Save**.



**NOTE:** By default, the network Proxy is set to None and the IP settings is set to DHCP. See [Configuring for a Proxy Server](#) on page 127 for setting the connection to a proxy server and see [Configuring the Device to Use a Static IP Address](#) on page 127 for setting the device to use a static IP address.


9. If network security is **WPA/WPA2/WPA3 Enterprise**:
  - a) Touch the **EAP method** drop-down list and select one of the following:
    - **PEAP**
    - **TLS**
    - **TTLS**
    - **PWD**
    - **SIM**
    - **AKA**
    - **AKA'**
    - **LEAP**
  - b) Fill in the appropriate information. Options vary depending on the **EAP method** chosen.
    - When selecting **CA certificate**, Certification Authority (CA) certificates are installed using the **Security** settings.
    - When using the EAP methods PEAP, TLS, or TTLS, specify a domain.
    - Touch **Advanced options** to display additional network options.

10. If the network security is WPA3-Enterprise 192-bit:
  - Touch **CA certificate** and select a Certification Authority (CA) certificate. Note: Certificates are installed using the Security settings.
  - Touch **User certificate** and select a user certificate. Note: User certificates are installed using the Security settings.
  - In the **Identity** text box, enter the username credentials.
11. Touch **Save**. To connect to the saved network, touch and hold on the saved network and select **Connect to network**.

## Configuring for a Proxy Server

A proxy server is a server that acts as an intermediary for requests from clients seeking resources from other servers. A client connects to the proxy server and requests some service, such as a file, connection, web page, or other resource, available from a different server. The proxy server evaluates the request according to its filtering rules. For example, it may filter traffic by IP address or protocol. If the request is validated by the filter, the proxy provides the resource by connecting to the relevant server and requesting the service on behalf of the client.


It is important for enterprise customers to be able to set up secure computing environments within their companies, making proxy configuration essential. Proxy configuration acts as a security barrier ensuring that the proxy server monitors all traffic between the Internet and the intranet. This is normally an integral part of security enforcement in corporate firewalls within intranets.

1. Go to **Settings**.
2. Touch **Network & Internet > Wi-Fi**.
3. Slide the Wi-Fi switch to the **On** position.
4. In the network dialog box, select and touch a network.
5. If configuring the connected network, touch  to edit the network details and then touch the down arrow to hide the keyboard.
6. Touch **Advanced options**.
7. Touch **Proxy** and select **Manual**.
8. In the **Proxy hostname** text box, enter the address of the proxy server.
9. In the **Proxy port** text box, enter the port number for the proxy server.
10. In the **Bypass proxy for** text box, enter addresses for web sites that are not required to go through the proxy server. Use a comma “,” between addresses. Do not use spaces or carriage returns between addresses.
11. If configuring the connected network, touch **Save** otherwise, touch **Connect**.
12. Touch **Connect**.

## Configuring the Device to Use a Static IP Address

By default, the device is configured to use Dynamic Host Configuration Protocol (DHCP) to assign an Internet protocol (IP) address when connecting to a wireless network.

1. Go to **Settings**.
2. Touch **Network & Internet > Wi-Fi**.

3. Slide the Wi-Fi switch to the **On** position.
4. In the network dialog box, select and touch a network.
5. If configuring the connected network, touch  to edit the network details and then touch the down arrow to hide the keyboard.
6. Touch **Advanced options**.
7. Touch **IP settings** and select **Static**.
8. In the **IP address** text box, enter an IP address for the device.
9. If required, in the **Gateway** text box, enter a gateway address for the device.
10. If required, in the **Network prefix length** text box, enter the prefix length.
11. If required, in the **DNS 1** text box, enter a Domain Name System (DNS) address.
12. If required, in the **DNS 2** text box, enter a DNS address.
13. If configuring the connected network, touch **Save** otherwise, touch **Connect**.

## Wi-Fi Preferences

Use the Wi-Fi preferences to configure advanced Wi-Fi settings. From the Wi-Fi screen scroll down to the bottom of the screen and touch Wi-Fi preferences.

- **Turn on Wi-Fi automatically** - When enabled, Wi-Fi automatically turns back on when near high-quality saved networks.
- **Open network notification** - When enabled, notifies the user when an open network is available.
- **Advanced** - Touch to expand options.
  - **Additional settings** - Touch to view additional Wi-Fi settings.
  - **Install Certificates** – Touch to install certificates.
  - **Network rating provider** - Disabled (AOSP devices). To help determine what constitutes a good Wi-Fi network, Android supports external Network rating providers that provide information about the quality of open Wi-Fi networks. Select one of the providers listed or **None**. If none are available or selected, the Connect to open networks feature is disabled.
  - **Wi-Fi Direct** - Displays a list of devices available for a direct Wi-Fi connection.

## Additional Wi-Fi Settings

Use the Additional Settings to configure additional Wi-Fi settings. To view the additional Wi-Fi settings, scroll to the bottom of the Wi-Fi screen and touch **Wi-Fi Preferences > Advanced > Additional settings**.



**NOTE:** Additional Wi-Fi settings are for the device, not for a specific wireless network.

- **Regulatory**
  - **Country Selection** - Displays the acquired country code if 802.11d is enabled, else it displays the currently selected country code.
  - **Region code** - Displays the current region code.



- **Band and Channel Selection**
  - **Wi-Fi frequency band** - Set the frequency band to: **Auto** (default), **5 GHz only** or **2.4 GHz only**.
  - **Available channels (2.4 GHz)** - Touch to display the **Available channels** menu. Select specific channels and touch **OK**.
  - **Available channels (5 GHz)** - Touch to display the **Available channels** menu. Select specific channels and touch **OK**.
- **Logging**
  - **Advanced Logging** – Touch to enable advanced logging or change the log directory.
  - **Wireless logs** - Use to capture Wi-Fi log files.
    - **Fusion Logger** - Touch to open the **Fusion Logger** application. This application maintains a history of high level WLAN events which helps to understand the status of connectivity.
    - **Fusion Status** - Touch to display live status of WLAN state. Also provides information about the device and connected profile.
- **About**
  - **Version** - Displays the current version information. Touch the version to display addition version details.

## Wi-Fi Direct

Wi-Fi Direct devices can connect to each other without having to go through an access point. Wi-Fi Direct devices establish their own ad-hoc network when required, letting you see which devices are available and choose which one you want to connect to.

1. Go to **Settings**.
2. Touch **Network & Internet** > **Wi-Fi**.
3. Slide the **Wi-Fi** switch to the **On** position.
4. In the network dialog box, select and touch a network.
5. Scroll down to the bottom of the screen and touch **Wi-Fi preferences** > **Advanced** > **Wi-Fi Direct**. The device begins searching for another Wi-Fi Direct device.
6. Under **Peer devices**, touch the other device name.
7. On the other device, select **Accept**.

**Connected** appears on the device. On both devices, in their respective Wi-Fi Direct screens, the other device name appears in the list.

## Bluetooth

Bluetooth devices can communicate without wires, using frequency-hopping spread spectrum (FHSS) radio frequency (RF) to transmit and receive data in the 2.4 GHz Industry Scientific and Medical (ISM) band (802.15.1). Bluetooth wireless technology is specifically designed for short-range (10 m (32.8 ft)) communication and low power consumption.

Devices with Bluetooth capabilities can exchange information (for example, files, appointments, and tasks) with other Bluetooth enabled devices such as printers, access points, and other mobile devices.

The device supports Bluetooth Low Energy. Bluetooth Low Energy is targeted at applications in the healthcare, fitness, security, and home entertainment industries. It provides reduced power consumption and cost while maintaining standard Bluetooth range.

## Adaptive Frequency Hopping

Adaptive Frequency Hopping (AFH) is a method of avoiding fixed frequency interferers, and can be used with Bluetooth voice. All devices in the piconet (Bluetooth network) must be AFH-capable in order for AFH to work. There is no AFH when connecting and discovering devices. Avoid making Bluetooth connections and discoveries during critical 802.11b communications.

AFH for Bluetooth consists of four main sections:

- Channel Classification - A method of detecting an interference on a channel-by-channel basis, or pre-defined channel mask.
- Link Management - Coordinates and distributes the AFH information to the rest of the Bluetooth network.
- Hop Sequence Modification - Avoids interference by selectively reducing the number of hopping channels.
- Channel Maintenance - A method for periodically re-evaluating the channels.

When AFH is enabled, the Bluetooth radio “hops around” (instead of through) the 802.11b high-rate channels. AFH coexistence allows enterprise devices to operate in any infrastructure.

The Bluetooth radio in this device operates as a Class 2 device power class. The maximum output power is 2.5 mW and the expected range is 10 m (32.8 ft). A definition of ranges based on power class is difficult to obtain due to power and device differences, and whether in open space or closed office space.



**NOTE:** It is not recommended to perform Bluetooth wireless technology inquiry when high rate 802.11b operation is required.

## Security

The current Bluetooth specification defines security at the link level. Application-level security is not specified. This allows application developers to define security mechanisms tailored to their specific need. Link-level security occurs between devices, not users, while application-level security can be implemented on a per-user basis. The Bluetooth specification defines security algorithms and procedures required to authenticate devices, and if needed, encrypt the data flowing on the link between the devices. Device authentication is a mandatory feature of Bluetooth while link encryption is optional.

Pairing of Bluetooth devices is accomplished by creating an initialization key used to authenticate the devices and create a link key for them. Entering a common personal identification number (PIN) in the devices being paired generates the initialization key. The PIN is never sent over the air. By default, the Bluetooth stack responds with no key when a key is requested (it is up to user to respond to the key request event). Authentication of Bluetooth devices is based-upon a challenge-response transaction. Bluetooth allows for a PIN or passkey used to create other 128-bit keys used for security and encryption. The encryption key is derived from the link key used to authenticate the pairing devices. Also worthy of note is the limited range and fast frequency hopping of the Bluetooth radios that makes long-distance eavesdropping difficult.

Recommendations are:

- Perform pairing in a secure environment
- Keep PIN codes private and do not store the PIN codes in the device

- Implement application-level security.

## Bluetooth Profiles

The device supports the Bluetooth services listed.

**Table 24** Bluetooth Profiles

Profile	Description
Service Discovery Protocol (SDP)	Handles the search for known and specific services as well as general services.
Serial Port Profile (SPP)	Allows use of RFCOMM protocol to emulate serial cable connection between two Bluetooth peer devices. For example, connecting the device to a printer.
Object Push Profile (OPP)	Allows the device to push and pull objects to and from a push server.
Advanced Audio Distribution Profile (A2DP)	Allows the device to stream stereo-quality audio to a wireless headset or wireless stereo speakers.
Audio/Video Remote Control Profile (AVRCP)	Allows the device to control A/V equipment to which a user has access. It may be used in concert with A2DP.
Personal Area Network (PAN)	Allows the use of Bluetooth Network Encapsulation Protocol to provide L3 networking capabilities over a Bluetooth link. Only PANU role is supported.
Human Interface Device Profile (HID)	Allows Bluetooth keyboards, pointing devices, gaming devices and remote monitoring devices to connect to the device.
Headset Profile (HSP)	Allows a hands-free device, such as a Bluetooth headset, to place and receive calls on the device.
Hands-Free Profile (HFP)	Allows car hands-free kits to communicate with the device in the car.
Phone Book Access Profile (PBAP)	Allows exchange of Phone Book Objects between a car kit and a mobile device to allow the car kit to display the name of the incoming caller; allow the car kit to download the phone book so you can initiate a call from the car display.
Out of Band (OOB)	Allows exchange of information used in the pairing process. Pairing is initiated by NFC but completed using the Bluetooth radio. Pairing requires information from the OOB mechanism. Using OOB with NFC enables pairing when devices simply get close, rather than requiring a lengthy discovery process.
Symbol Serial Interface (SSI)	Allows for communication with Bluetooth Imager.

## Bluetooth Power States

The Bluetooth radio is off by default.

- **Suspend** - When the device goes into Sleep mode, the Bluetooth radio stays on.
- **Airplane Mode** -
  - Android A10 OS version and previous versions - When the device is placed in Airplane Mode, the Bluetooth radio turns off. When Airplane mode is disabled, the Bluetooth radio returns to the prior state. When in Airplane Mode, the Bluetooth radio can be turned back on if desired.
  - Android A11 OS version and versions onward - When the device is placed in Airplane Mode, the Bluetooth radio is not turned off when the device is connected to a Bluetooth headset or hearing device.


## Bluetooth Radio Power

Turn off the Bluetooth radio to save power or if entering an area with radio restrictions (for example, an airplane). When the radio is off, other Bluetooth devices cannot see or connect to the device. Turn on the Bluetooth radio to exchange information with other Bluetooth devices (within range). Communicate only with Bluetooth radios in close proximity.




**NOTE:** To achieve the best battery life, turn off radios when not in use.

### Enabling Bluetooth

1. Swipe down from the Status bar to open the Notification panel.
2. Touch  to turn Bluetooth on.

### Disabling Bluetooth

1. Swipe down from the Status bar to open the Notification panel.
2. Touch  to turn Bluetooth off.

## Discovering Bluetooth Device(s)

The device can receive information from discovered devices without pairing. However, once paired, the device and a paired device exchange information automatically when the Bluetooth radio is on.

1. Ensure that Bluetooth is enabled on both devices.
2. Ensure that the Bluetooth device to discover is in discoverable mode.
3. Ensure that the two devices are within 10 meters (32.8 feet) of one another.
4. Swipe down from the Status bar to open the Quick Access panel.
5. Touch and hold **Bluetooth**.
6. Touch **Pair new device**. The device begins searching for discoverable Bluetooth devices in the area and displays them under **Available devices**.
7. Scroll through the list and select a device. The Bluetooth pairing request dialog box appears.

8. Touch **Pair** on both devices.
9. The Bluetooth device is added to the **Paired devices** list and a trusted (“paired”) connection is established.

## Changing the Bluetooth Name

By default, the device has a generic Bluetooth name that is visible to other devices when connected.

1. Go to **Settings**.
2. Touch **Connected devices > Connection preferences > Bluetooth**.
3. If Bluetooth is not on, move the switch to turn Bluetooth on.
4. Touch **Device name**.
5. Enter a name and touch **RENAME**.

## Connecting to a Bluetooth Device


Once paired, connect to a Bluetooth device.

1. Go to **Settings**.
2. Touch **Connected devices > Connection preferences > Bluetooth**.
3. In the list, touch the unconnected Bluetooth device.

When connected, **Connected** appears below the device name.

## Selecting Profiles on the Bluetooth Device

Some Bluetooth devices have multiple profiles.

1. Go to **Settings**.
2. Touch **Connected devices > Connection preferences > Bluetooth**.
3. In the **Paired Devices** list, touch  next to the device name.
4. Turn on or off a profile to allow the device to use that profile.

## Unpairing a Bluetooth Device

Unpairing a Bluetooth device erases all pairing information.

1. Go to **Settings**.
2. Touch **Connected devices > Connection preferences > Bluetooth**.
3. In the **Paired Devices** list, touch  next to the device name.
4. Touch **FORGET**.

## Using a Bluetooth Headset

Use a Bluetooth headset for audio communication when using an audio-enabled app. See Bluetooth for more information on connecting a Bluetooth headset to the device. Set the volume appropriately before putting on the headset. When a Bluetooth headset is connected, the speakerphone is muted.

## Cast

Use **Cast** to mirror the device screen on a Miracast enabled wireless display.

1. Go to **Settings**.
2. Touch **Connected devices** > **Connection preferences** > **Cast**.
3. Touch **⋮** > **Enable wireless display**.

The device searches for nearby Miracast devices and lists them.

4. Touch a device to begin casting.

## Near Field Communications

NFC/HF RFID is a short-range wireless connectivity technology standard that enables a secure transaction between a reader and a contactless smartcard.

The technology is based on ISO/IEC 14443 type A and B (proximity) ISO/IEC 15693 (vicinity) standards, using the HF 13.56 MHz unlicensed band.

The device supports the following operating modes:

- Reader mode
- Card Emulation mode.

Using NFC, the device can:

- Read contactless cards such as contactless tickets, ID cards and ePassport.
- Read and write information to contactless cards such as SmartPosters and tickets, as well as devices with NFC interface such as vending machines.
- Read information from supported medical sensors.
- Pair with supported Bluetooth devices such as printers, ring scanners (for example, RS6000), and headsets (for example, HS3100).
- Exchange data with another NFC device.
- Emulate contactless cards such as payment, ticket, or SmartPoster.

The device NFC antenna is positioned to read NFC cards from the top of the device while the device is being held.

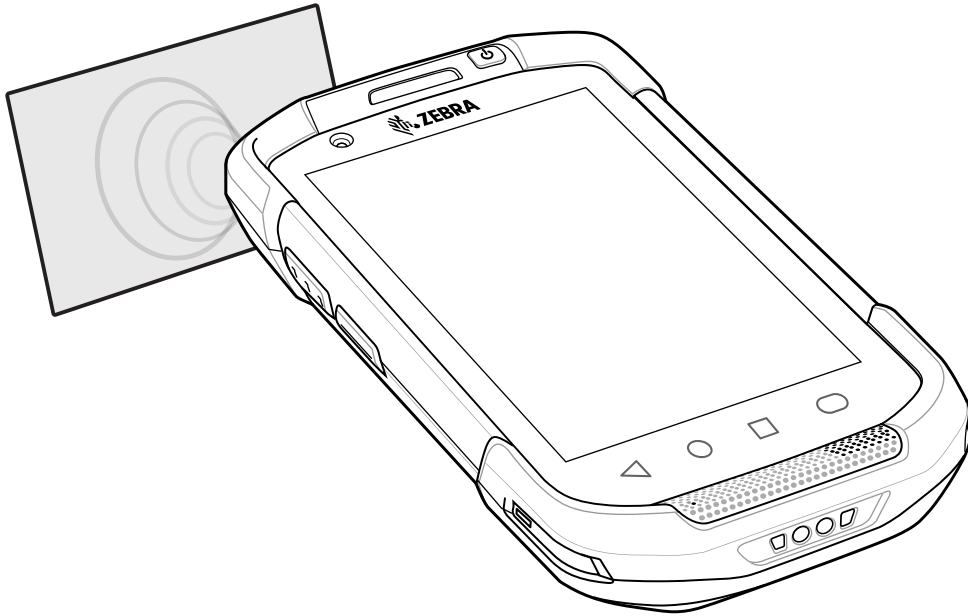
The device NFC antenna is located on the back of the device, near the Interface Connector.

## Reading NFC Cards

Read contactless cards using NFC.

1. Launch an NFC enabled application.

2. Hold device as shown.



3. Move the device close to the NFC card until it detects the card.
4. Hold the card steadily until the transaction is complete (usually indicated by the application).

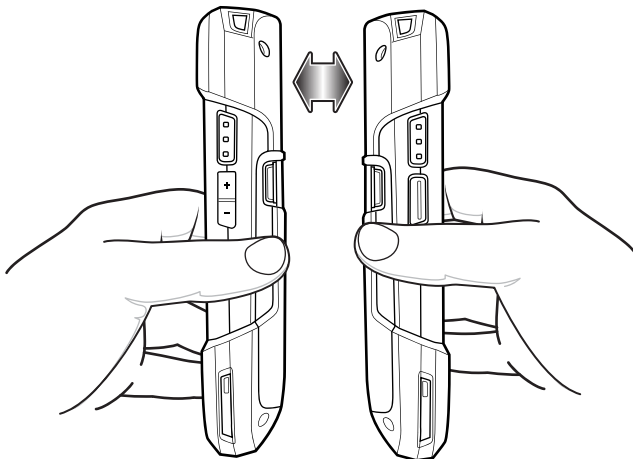
## Sharing Information Using NFC

You can beam content like a web page, contact cards, pictures, YouTube links, or location information from your screen to another device by bringing the devices together back to back.

Make sure both devices are unlocked, support NFC, and have both NFC and Android Beam turned on.

1. Open a screen that contains a web page, video, photo or contact.
2. Move the front of the device toward the front of the other device.

When the devices connect, a sound emits, the image on the screen reduces in size, the message **Touch to beam** displays.



3. Touch anywhere on the screen.

The transfer begins.

## Enterprise NFC Settings

Improve NFC performance or increase battery life by selecting which NFC features to use on the device.

- **Card Detection Mode** - Select a card detection mode.
  - **Low** - Increases battery life by lowering the NFC detection speed.
  - **Hybrid** - Provides a balance between NFC detection speed and battery life (default).
  - **Standard** - Provides the optimal NFC detection speed, but reduces battery life.
- **Supported Card Technology** - Select an option to detect only one NFC tag type, increasing battery life, but reducing detection speed.
  - **All (Default)** - Detects all NFC tag types. This provides the best detection speed, but reduces battery life.
  - **ISO 14443 Type A**
  - **ISO 14443 Type B**
  - **ISO 15693**
- **NFC Debug Logging** - Use to enable or disable debug logging for NFC.
- **Other NFC settings available with Zebra administrator tools (CSP)** - Allows configuration of additional Enterprise NFC Settings through staging tools and Mobile Device Management (MDM) solutions with an MX version that supports the Enterprise NFC Settings Configuration Service Provider (CSP). For more information on using the Enterprise NFC Settings CSP, refer to: [techdocs.zebra.com](https://techdocs.zebra.com).



# Calls

Make a phone call from the Phone app, the Contacts app, or other apps or widgets that display contact information.



**NOTE:** This section applies to WWAN devices only.

## Emergency Calling

The service provider programs one or more emergency phone numbers, such as 911 or 999, that the user can call under any circumstances, even when the phone is locked, a SIM card is not inserted or the phone is not activated. The service provider can program additional emergency numbers into the SIM card. However, the SIM card must be inserted in the device in order to use the numbers stored on it. See the service provider for additional information.



**NOTE:** Emergency numbers vary by country. The phone's pre-programmed emergency number(s) may not work in all locations, and sometimes an emergency call cannot be placed due to network, environmental, or interference issues

## Audio Modes

The device offers three audio modes for use during phone calls.

- Handset Mode - Switch audio to the receiver at the top front of the device to use the device as a handset. This is the default mode.
- Speaker Mode - Use the device as a speakerphone.
- Headset Mode - Connect a Bluetooth or wired headset to automatically switch audio to the headset.

## Bluetooth Headset

Use a Bluetooth headset for audio communication when using an audio-enabled app.

Set the volume appropriately before putting on the headset. When a Bluetooth headset is connected, the speakerphone is muted.

## Wired Headset

Use a wired headset and audio adapter for audio communication when using an audio-enabled app. Set the volume appropriately before putting on the headset. When a wired headset is connected, the speakerphone is muted.

To end a call using the wired headset, press and hold the headset button until the call ends.




## Adjusting Audio Volume







Use the volume buttons to adjust the phone volume.

- Ring and notification volumes when not in a call.
- Conversation volume during a call.

## Making a Call Using the Dialer




Use the dialer tab to dial phone numbers.

1. On the Home screen touch .
2. Touch .
3. Touch the keys to enter the phone number.
4. Touch  below the dialer to initiate the call.

Option	Description
	Send audio to the speakerphone.
	Mute the call.
	Display the dial pad.
	Place the call on hold (not available on all services).
	Create a conference call.
	Increase audio level.


5. Touch  to end the call.

If using a Bluetooth headset, additional audio options are available. Touch the audio icon to open the audio menu.

Option	Description
	Audio is routed to the Bluetooth headset.
	Audio is routed to the speakerphone.
	Audio is routed to the earpiece.

## Accessing Dialing Options




The dialer provides options to save the dialed number to contacts, send an SMS, or insert pauses and wait into the dial string.







- Enter at least one digit in the dialer, then touch .
  - **Add 2-sec pause** - Pause the dialing of the next number for two seconds. Multiple pauses are added sequentially.
  - **Add wait** - Wait for confirmation to send the rest of the digits.

## Make a Call Using Contacts

There are two ways to make a call using contacts, using the Dialer or using the Contacts app.




### Using the Dialer

1. On the Home screen touch .
2. Touch .
3. Touch the contact.
4. Touch  to initiate the call.



Option	Description
	Send audio to the speakerphone.
	Mute the call.
	Display the dial pad.
	Place the call on hold (not available on all services).
	Create a conference call.
	Increase audio level.

5. Touch  to end the call.

If using a Bluetooth headset, additional audio options are available. Touch the audio icon to open the audio menu.

Option	Description
	Audio is routed to the Bluetooth headset.
	Audio is routed to the speakerphone.
	Audio is routed to the earpiece.

## Using the Contacts App




1. Touch .
2. Touch a contact name.
3. Touch  to initiate the call.

## Make a Call Using Call History





Call History is a list of all the calls placed, received, or missed. It provides a convenient way to redial a number, return a call, or add a number to Contacts.

Arrow icons beside a call indicate the type of call. Multiple arrows indicate multiple calls.

**Table 25** Call Type Indicators

Icon	Description
	Missed incoming call
	Received incoming call
	Outgoing call

## Using the Call History List




1. On the Home screen touch .
2. Touch the  tab.
3. Touch  next to the contact to initiate the call.
4. Touch the contact to perform other functions.
5. Touch  to end the call.









## Making a Conference Call on GSM




Create a conference phone session with multiple people



**NOTE:** Conference Calling and the number of conference calls allowed may not be available on all services. Please check with the service provider for Conference Calling availability.

1. On the Home screen touch .
2. Touch .
3. Touch the keys to enter the phone number.
4. Touch  below the dialer to initiate the call.

5. When the call connects, touch .  
The first call is placed on hold.
6. Touch .
7. Touch the keys to enter the second phone number.
8. Touch  below the dialer to initiate the call.  
When the call connects, the first call is placed on hold and the second call is active.
9. Touch  to create a conference call with three people.
10. Touch  to add another call.  
The conference is placed on hold.
11. Touch .
12. Touch the keys to enter another phone number.
13. Touch  below the dialer to initiate the call.
14. Touch  icon to add the third call to the conference.
15. Touch **Manage conference call** to view all callers.

Option	Description
	Remove a caller from the conference.
	Speak privately with one party during a conference call.
	Include all parties again.

## Making a Call Using a Bluetooth Headset



1. Pair the Bluetooth headset with the device.
2. Press the Call button on the Bluetooth headset.
3. Press the Call button on the Bluetooth headset to end the call.

## Answering Calls

When receiving a phone call, the **Incoming Call** screen displays the caller ID and any additional information about the caller that is in the **Contacts** app.






**NOTE:** Not all options are available for all configurations.

To modify phone call settings, on the Home screen touch  >  > **Settings**.

- Touch **ANSWER** to answer the call or **DECLINE** to send the caller to voice mail.

If the screen lock is enabled, the user can answer the call without unlocking the device.

- When a call arrives:
  - Touch  and slide up to answer the call.
  - Touch  and slide down to send the call to voice mail.
  - Touch  to open a list of quick text responses. Touch one to send it to the caller immediately.

When the calls ends, the device remains locked.

If using a Bluetooth headset when a call arrives, touch the Call button on the Bluetooth headset to answer the call. To end the call press the headset Call button.

All incoming calls are recorded in the Phone app Call log tab. If you miss a call, you receive a notification. To silence the ringer before answering the call, press the volume down button on the side of device.

## Call Settings

To modify phone call settings, on the Home screen touch  >  > **Settings**.



**NOTE:** Not all options are available for all configurations

- **Display options**
  - **Sort by** - Set to **First name** or **Last name**.
  - **Name format** - Set to **First name first** or **Last name first**.
- **Sounds and vibrations** - Touch to edit the general sound settings for the device.
- **Quick responses** - Touch to edit quick responses to use instead of answering a call.
- **Speed dial settings** - Set speed dial contact shortcuts.

- **Calling accounts**
  - **Settings** - Touch a mobile provider to display options for that provider.
    - **Fixed Dialing Numbers** - Set to only allow the phone to dial the phone number(s) or area code(s) specified in a Fixed Dialing list.
    - **Call forwarding** - Set to forward incoming calls to a different phone number.



**NOTE:** Call Forwarding may not be available on all networks. Check with the service provider for availability.

- **Additional Settings**
  - **Caller ID** - Set caller ID to reveal the identity of the person making an outgoing call. Options: Network default (default), Hide number, Show number.
  - **Call waiting** - Set to be notified of an incoming call while on a call.
- **SIP accounts** - Choose to receive Internet calls for accounts added to the device, view or change SIP accounts, or add an Internet calling account.
- **Use SIP calling** - Set to **For all calls** or **Only for SIP calls** (default).
- **Receive incoming calls** - Enable to allow incoming calls (default - disabled).
- **Wi-Fi calling** - Enable to allow Wi-Fi calling and set the Wi-Fi calling preference (default - disabled).
- **Call barring** - Set to block certain types of incoming or outgoing calls.
- **Blocked numbers** - Set to block calls and texts from certain phone numbers. Touch **ADD A NUMBER** to block a phone number.
- **Voicemail** - Configure voicemail settings.
  - **Notifications** - Configure voicemail notification settings.
    - **Importance** - Set the notification importance to Urgent, High (default), Medium, or Low.
    - **Alerting** - Touch to receive sound and vibration notifications when a voicemail is received. Use toggle switches to enable or disable Pop on screen, Blink light, Show notification dot, and Override Do Not Disturb.
    - **Silent** - Touch to silence sound and vibration notifications when a voicemail is received. Use toggle switches to enable or disable Minimize, Show notification dot, and Override Do Not Disturb.
    - **Sound** - Select a sound to play for notifications from this app.
    - **Vibrate** - Allow notifications from this app to vibrate the device.
    - **Blink light** - Allow notifications from this app the light the Notification LED blue.
    - **Show notification dot** - Allow notifications from this app to add a notification dot to the app icon.
    - **Override Do Not Disturb** - Allow these notifications to interrupt when Do Not Disturb is enabled.
  - **Advanced Settings**
    - **Service** - Set the service provider or other provider for voicemail service.
    - **Setup** - Select to update the phone number used to access voicemail.

- **Accessibility**
  - **Hearing aids** - Select to enable hearing air compatibility.
  - **RTT settings** - Configure Real-time text (RTT) settings.
    - **Real-time text (RTT) call** - Select to allow messaging during a call.
    - **Set RTT visibility** - Set to Visible during calls (default) or Always visible.



# Accessories

This section provides information for using the accessories for the device.

This following table lists the accessories available for the device.

**Table 26** Accessories

Accessory	Part Number	Description
<b>Cradles</b>		
2-Slot Charge Only Cradle	CRD-TC7X-SE2CPP-01	Provides device and spare battery charging. Use with power supply, p/n PWR-BGA12V50W0WW.
2-Slot USB/Ethernet Cradle	CRD-TC7X-SE2EPP-01	Provides device and spare battery charging and USB communication with a host computer and Ethernet communication with a network. Use with power supply, p/n PWR-BGA12V50W0WW.
5-Slot Charge Only Cradle	CRD-TC7X-SE5C1-01	Charges up to five devices. Use with power supply, p/n PWR-BGA12V108W0WW and DC line cord, p/n CBL-DC-381A1-01. Can accommodate one 4-Slot Battery Charger using the Battery Adapter Cup.
5-Slot Ethernet Cradle	CRD-TC7X-SE5EU1-01	Provides device charging and provides Ethernet communication for up to five devices. Use with power supply, p/n PWR-BGA12V108W0WW and DC line cord, p/n CBL-DC-381A1-01. Can accommodate one 4-Slot Battery Charger using the Battery Adapter Cup.
Cradle Mount	BRKT-SCRD-SMRK-01	Mounts the 5-Slot Charge Only Cradle, 5-Slot Ethernet Cradle, and 4-Slot Battery Charger to a wall or rack.
<b>Batteries and Chargers</b>		
4,620 mAh PowerPrecision+ battery	BTRY-TC7X-46MPP-01 BTRY-TC7X-46MPP-10	Replacement battery (single pack). Replacement battery (10-pack).
4-Slot Spare Battery Charger	SAC-TC7X-4BTYPP-01	Charges up to four battery packs. Use with power supply, p/n PWR-BGA12V50W0WW.

**Table 26** Accessories (Continued)

Accessory	Part Number	Description
Battery Charger Adapter Cup	CUP-SE-BTYADP1-01	Allows for one 4-Slot Battery Charger to be charged and docked on the left most slot of the 5-Slot cradles (maximum one per cradle).
<b>Vehicle Solutions</b>		
Charging Cable Cup	CHG-TC7X-CLA1-01	Provides power to the device from a cigarette lighter socket.
Charge Only Vehicle Cradle	CRD-TC7X-CVCD1-01	Charges and securely holds the device. Requires power cable CHG-AUTO-CLA1-01 or CHG-AUTO-HWIRE1-01, sold separately.
TC7X Data Communication Enabled Vehicle Cradle with Hub Kit	CRD-TC7X-VCD1-01	Contains the TC7X Vehicle Communication Charging Cradle and the USB I/O Hub.
Cigarette Light Adapter Auto Charge Cable	CHG-AUTO-CLA1-01	Provides power to the Vehicle Cradle from a cigarette lighter socket.
Hard-wire Auto Charge Cable	CHG-AUTO-HWIRE1-01	Provides power to the Vehicle Cradle from the vehicle's power panel.
RAM Mount	RAM-B-166U	Provides window mounting option for the Vehicle Cradle. RAM Twist Lock Suction Cup with Double Socket Arm and Diamond Base Adapter. Overall Length: 6.75".
RAM Mount Base	RAM-B-238U	RAM 2.43" x 1.31" Diamond Ball base with 1" ball.
<b>Charge and Communication Cables</b>		
Charging Cable Cup	CHG-TC7X-CBL1-01	Provides power to the device. Use with power supply, p/n PWR-BUA5V16W0WW, sold separately.
Snap-On USB Cable	CBL-TC7X-USB1-01	Provides power to the device and USB communication with a host computer. Use with power supply, p/n PWR-BUA5V16W0WW, sold separately.
MSR Adapter	MSR-TC7X-SNP1-01	Provides power and USB communication with a host computer. Use with USB-C cable, sold separately.
Snap-On DEX Cable	CBL-TC7X-DEX1-01	Provides electronic data exchange with devices such as vending machines.
<b>Audio Accessories</b>		
Rugged Headset	HS2100-OTH	Rugged wired headset. Includes HS2100 Boom Module and HSX100 OTH Headband Module.
Bluetooth Headset	HS3100-OTH	Rugged Bluetooth Headset. Includes HS3100 Boom Module and HSX100 OTH Headband Module.
3.5 mm Audio Adapter	ADP-TC7X-AUD35-01	Snaps onto the device and provides audio to a wired headset with 3.5 mm plug.

**Table 26** Accessories (Continued)

Accessory	Part Number	Description
3.5 mm Headset	HDST-35MM-PTVP-01	Use for PTT and VoIP calls.
3.5 mm Quick Disconnect Adapter Cable	ADP-35M-QDCBL1-01	Provides connection to the 3.5 mm Headset.
<b>Scanning</b>		
Trigger Handle	TRG-TC7X-SNP1-02	Adds gun-style handle with a scanner trigger for comfortable and productive scanning.
Trigger Handle Attach Plate with Tether	ADP-TC7X-CLH10-10	Trigger Handle Attach Plate with tether. Allows for installation of the Trigger Handle (10-pack). Use with charge only cradles.
Trigger Handle Attach Plate	ADP-TC7X-CLPTH1-20	Trigger Handle Attach Plate. Allows for installation of the Trigger Handle (20-pack). Use with Ethernet and charge only cradles.
<b>Carrying Solutions</b>		
Soft Holster	SG-TC7X-HLSTR1-02	TC7X soft holster.
Rigid Holster	SG-TC7X-RHLSTR1-01	TC7X rigid holster.
Hand Strap	SG-TC7X-HSTRP2-03	Replacement hand strap with hand strap mounting clip (3-pack).
Stylus and Coiled Tether	SG-TC7X-STYLUS-03	TC7X stylus with coiled tether (3-pack).
Screen Protector	SG-TC7X-SCRNTMP-01	Provides additional protection for the screen (1-pack).
<b>Power Supplies</b>		
Power Supply	PWR-BUA5V16W0WW	Provides power to the device using the Snap-On USB Cable, Snap-on Serial Cable or Charging Cable Cup. Requires DC Line Cord, p/n DC-383A1-01 and country specific three wire grounded AC line cord sold separately.
Power Supply	PWR-BGA12V50W0WW	Provides power to the 2-Slot cradles and 4-Slot Spare Battery Charger. Requires DC Line Cord, p/n CBL-DC-388A1-01 and country specific three wire grounded AC line cord sold separately.
Power Supply	PWR-BGA12V108W0WW	Provides power to the 5-Slot Charge Only cradle and the 5-Slot Ethernet Cradle. Requires DC Line Cord, p/n CBL-DC-381A1-01 and country specific three wire grounded AC line cord sold separately.
DC Line Cord	CBL-DC-388A1-01	Provides power from the power supply to the 2-Slot cradles and 4-Slot Spare Battery Charger.
DC Line Cord	CBL-DC-381A1-01	Provides power from the power supply to the 5-Slot Charge Only Cradle and 5-Slot Ethernet Cradle.

## Battery Charging

Charge the device with a battery installed or charge spare batteries.

### Main Battery Charging

The device's Charging/Notification LED indicates the status of the battery charging in the device.

The 4,620 mAh battery fully charges in less than five hours at room temperature.

### Spare Battery Charging

The spare battery Charging LED on the cup indicates the status of the spare battery charging.

The 4,620 mAh battery fully charges in less than five hours at room temperature.

**Table 27** Spare Battery Charging LED Indicators

LED	Indication
Slow Blinking Amber	Spare battery is charging.
Solid Green	Charging complete.
Fast Blinking Amber	Error in charging; check placement of spare battery.
Slow Blinking Red	Spare battery is charging and battery is at the end of useful life.
Solid Red	Charging complete and battery is at the end of useful life.
Fast Blinking Red	Error in charging; check placement of spare battery and battery is at the end of useful life.
Off	No spare battery in slot; spare battery not placed correctly; cradle is not powered.

## Charging Temperature

Charge batteries in temperatures from 0°C to 40°C (32°F to 104°F). The device or cradle always performs battery charging in a safe and intelligent manner. At higher temperatures (e.g. approximately +37°C (+98°F)) the device or cradle may for small periods of time alternately enable and disable battery charging to keep the battery at acceptable temperatures. The device and cradle indicates when charging is disabled due to abnormal temperatures via its LED.

## 2-Slot Charge Only Cradle

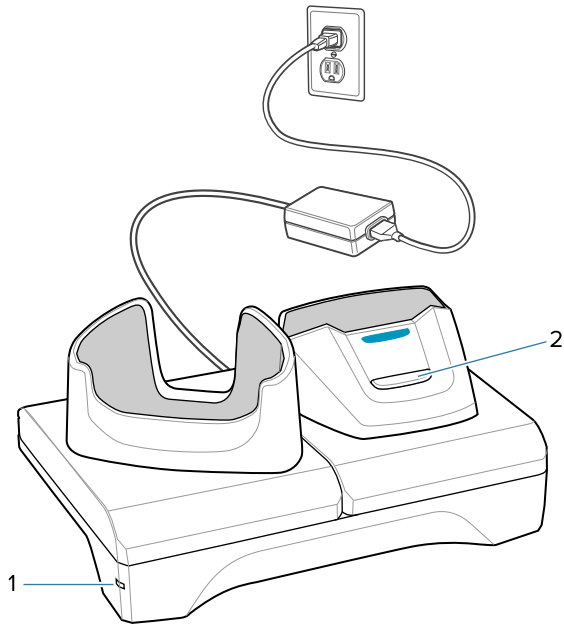


**CAUTION:** Ensure that you follow the guidelines for battery safety described in [Battery Safety Guidelines](#) on page 234.

The 2-Slot Charge Only Cradle:

- Provides 5 VDC power for operating the device.
- Charges the device's battery.
- Charges a spare battery.

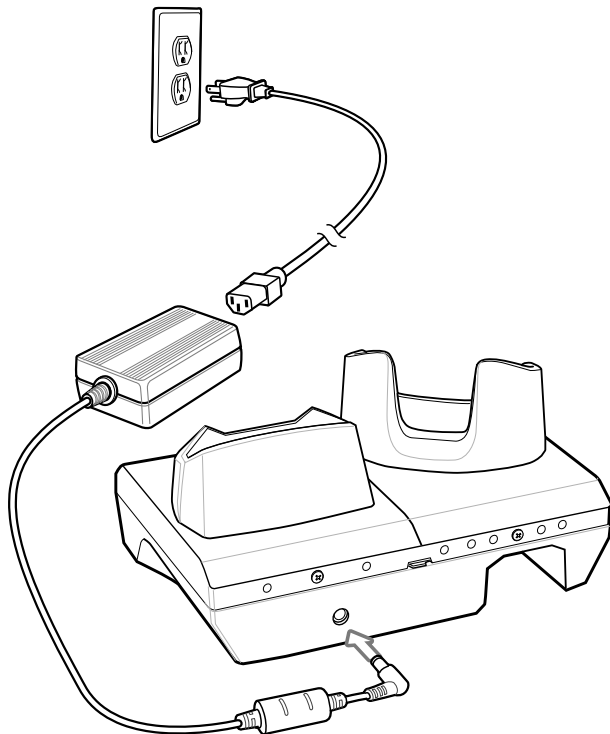
**Figure 33** 2-Slot Charge Only Cradle



1	Power LED
2	Spare battery charging LED

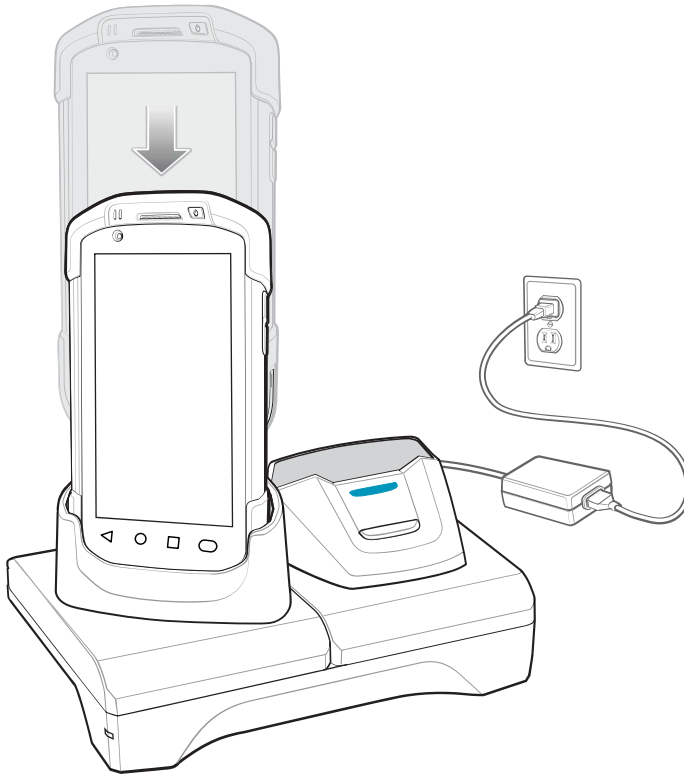
## 2-Slot Charge Only Cradle Setup

The 2-Slot Charge Only Cradle provides charging for one device and one spare battery.



## Charging the Device with the 2-Slot Charge Only Cradle

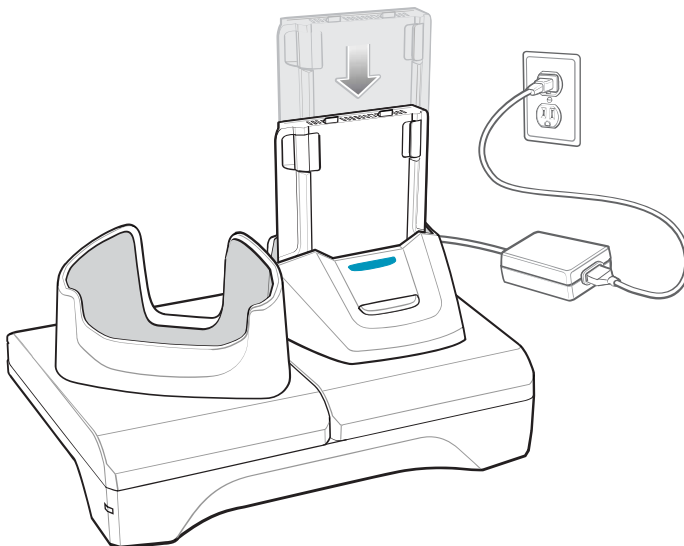
1. Insert the device into the slot to begin charging.



2. Ensure the device is seated properly.

## Charging the Spare Battery with the 2-Slot Charge Only Cradle

1. Insert the battery into the right slot to begin charging.



2. Ensure the battery is seated properly.

## 2-Slot USB-Ethernet Cradle



**CAUTION:** Ensure that you follow the guidelines for battery safety described in [Battery Safety Guidelines](#) on page 234.

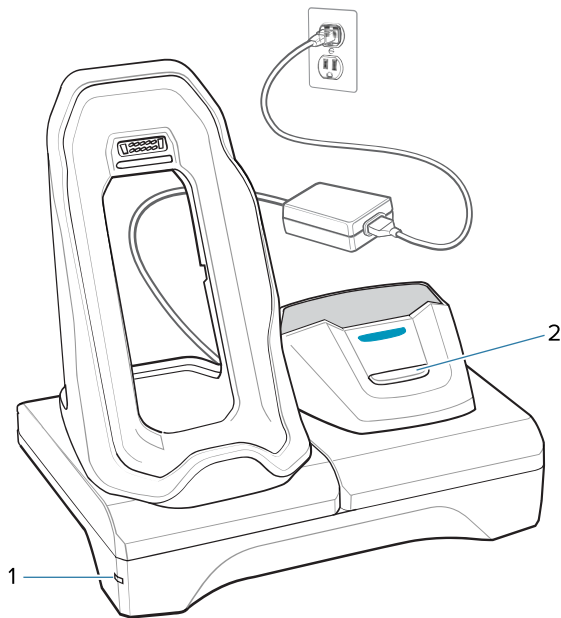
The 2-Slot USB/Ethernet Cradle:

- Provides 5.0 VDC power for operating the device.
- Charges the device's battery.
- Charges a spare battery.
- Connects the device to an Ethernet network.
- Provides communication to a host computer using a USB cable.



**NOTE:** Remove all attachments on the device, except the hand strap, before place onto the cradle.

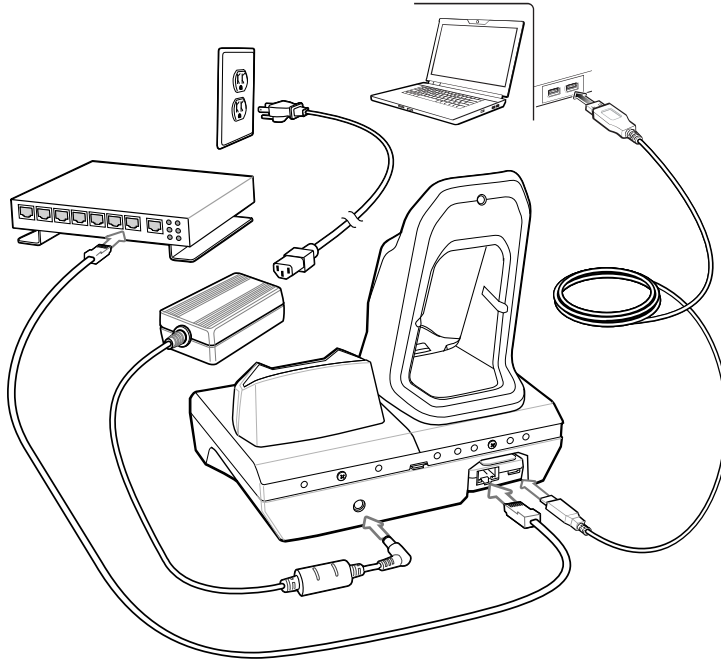
**Figure 34** 2-Slot USB/Ethernet Cradle



1	Power LED
2	Spare battery charging LED

## 2-Slot USB-Ethernet Cradle Setup

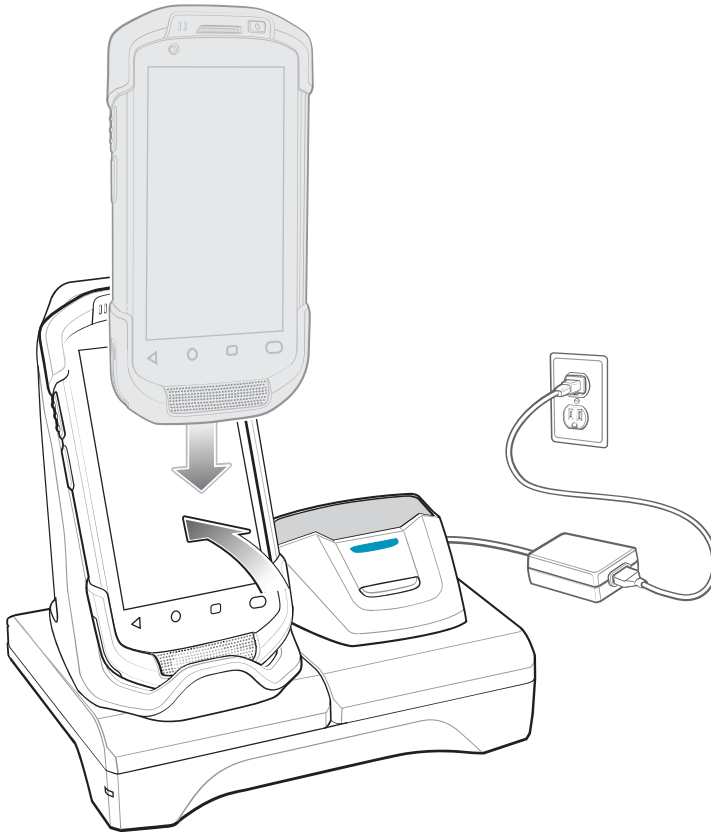
The 2-Slot USB/Ethernet Cradle provides USB and Ethernet communication for a device. Charging is also provided for the device and one spare battery.





## Charging the Device with the 2-Slot USB-Ethernet Cradle

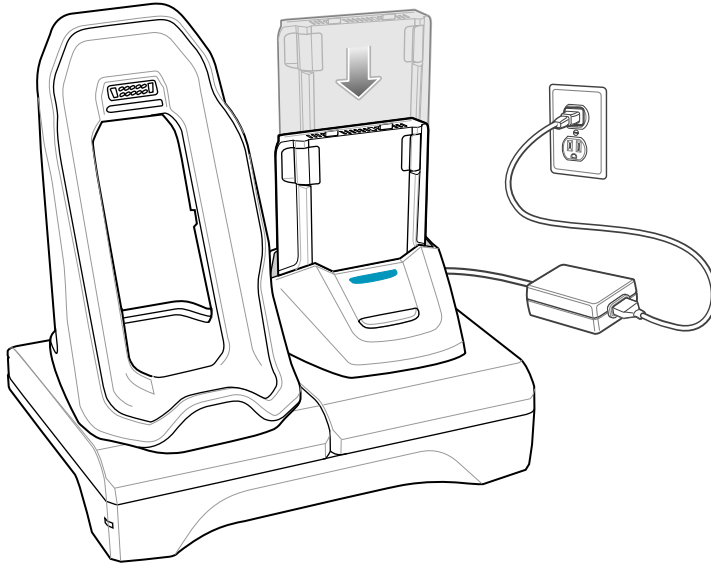
1. Place the bottom of the device into the base.



2. Rotate the top of the device until the connector on the back of the device mates with the connector on the cradle.
3. Ensure the device is connected properly. The charging Charging/Notification LED on the device begins blinking amber indicating that the device is charging.

## Charging the Spare Battery with the 2-Slot USB-Ethernet Cradle

1. Insert the battery into the right slot to begin charging.



2. Ensure the battery is seated properly.

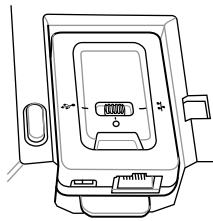
## USB and Ethernet Communication




The 2-Slot USB/Ethernet Cradle provides both Ethernet communication with a network and USB communication with a host computer. Prior to using the cradle for Ethernet or USB communication, ensure that the switch on the USB/Ethernet module is set properly.

### Setting the USB Ethernet Module

- Turn the cradle over to view the module.

**Figure 35** 2-Slot USB/Ethernet Cradle Module Switch



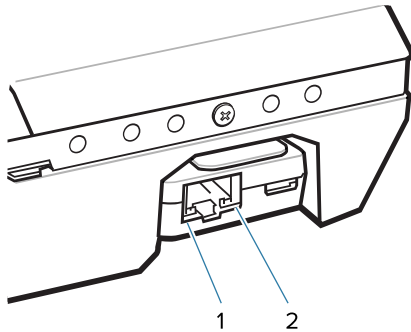
- For Ethernet communication, slide the switch to the  position.
- For USB communication, slide the switch to the  position.
- Place the switch in the center position  to disable communications.

### Ethernet Module LED Indicators

There are two LEDs on the USB/Ethernet Module RJ-45 connector. The green LED lights to indicate that the transfer rate is 100 Mbps. When the LED is not lit the transfer rate is 10 Mbps. The yellow LED blinks to

indicate activity, or stays lit to indicate that a link is established. When it is not lit it indicates that there is no link.

**Figure 36** LED Indicators




1	Yellow LED
2	Green LED

**Table 28** USB/Ethernet Module LED Data Rate Indicators

Data Rate	Yellow LED	Green LED
100 Mbps	On/Blink	On
10 Mbps	On/Blink	Off

### Establishing Ethernet Connection

1. Go to **Settings**.
2. Touch **Network & internet**>**Ethernet**.
3. Slide the Ethernet switch to the **ON** position.
4. Insert the device into a slot.

The  icon appears in the Status bar.

5. Touch **Eth0** to view Ethernet connection details.

### Configuring Ethernet Proxy Settings

The device includes Ethernet cradle drivers. After inserting the device, configure the Ethernet connection.

1. Go to **Settings**.
2. Touch **Network & internet**>**Ethernet**.
3. Place the device into the Ethernet cradle slot.
4. Slide the switch to the **ON** position.
5. Touch and hold **Eth0** until the menu appears.
6. Touch **Modify Proxy**.
7. Touch the **Proxy** drop-down list and select **Manual**.

8. In the **Proxy hostname** field, enter the proxy server address.
9. In the **Proxy port** field, enter the proxy server port number.



**NOTE:** When entering proxy addresses in the Bypass proxy for field, do not use spaces or carriage returns between addresses.

10. In the **Bypass proxy for** text box, enter addresses for web sites that do not require to go through the proxy server. Use the separator “|” between addresses.
11. Touch **MODIFY**.
12. Touch Home.

## Configuring Ethernet Static IP Address

The device includes Ethernet cradle drivers. After inserting the device, configure the Ethernet connection:

1. Go to **Settings**.
2. Touch **Network & internet**>**Ethernet**.
3. Place the device into the Ethernet cradle slot.
4. Slide the switch to the **ON** position.
5. Touch **Eth0**.
6. Touch **Disconnect**.
7. Touch **Eth0**.
8. Touch and hold the IP settings drop-down list and select **Static**.
9. In the **IP** address field, enter the proxy server address.
10. If required, in the **Gateway** field, enter a gateway address for the device.
11. If required, in the **Netmask** field, enter the network mask address
12. If required, in the **DNS address** fields, enter a Domain Name System (DNS) addresses.
13. Touch **CONNECT**.
14. Touch Home.

## 5-Slot Charge Only Cradle

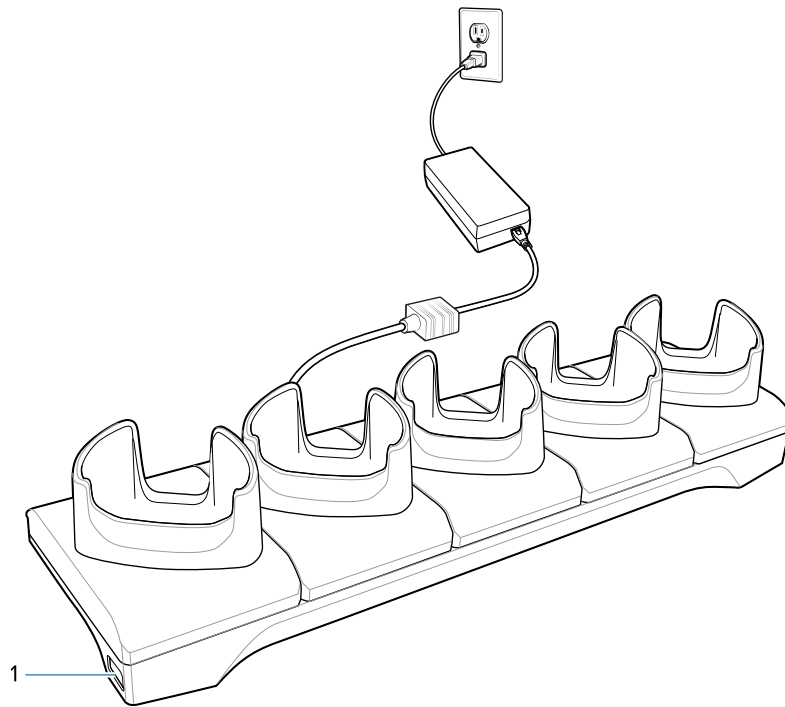


**CAUTION:** Ensure that you follow the guidelines for battery safety described in [Battery Safety Guidelines](#) on page 234.

The 5-Slot Charge Only Cradle:

- Provides 5 VDC power for operating the device.
- Simultaneously charges up to five devices and up to four devices and one 4-Slot Battery Charger using the Battery Charger Adapter.
- Consists of a cradle base and cups that can be configured for various charging requirements.

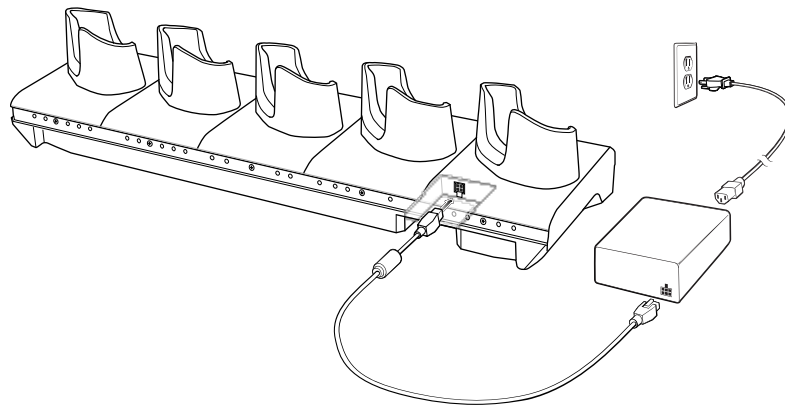
**Figure 37** 5-Slot Charge Only Cradle



1	Power LED
---	-----------

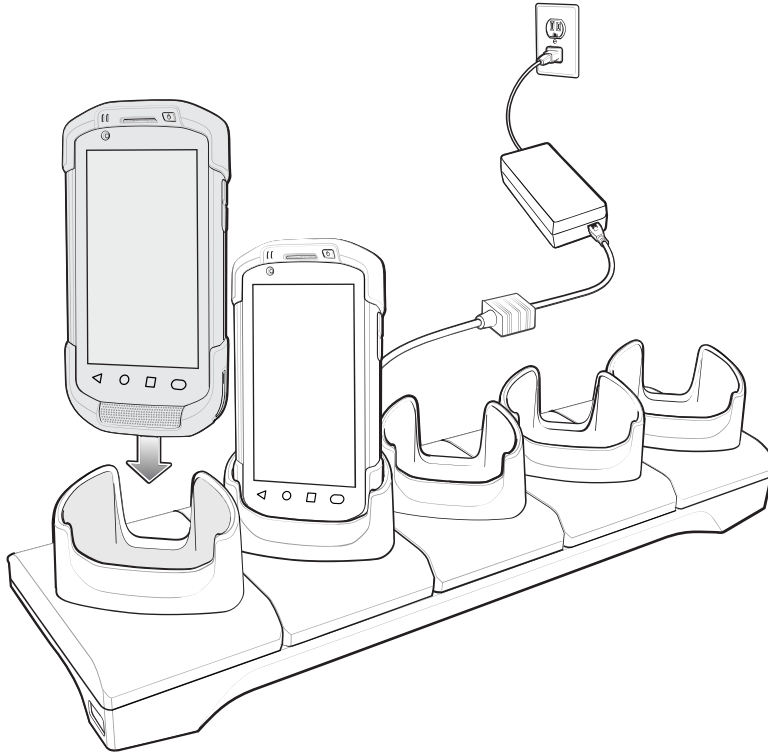
### 5-Slot Charge Only Cradle Setup

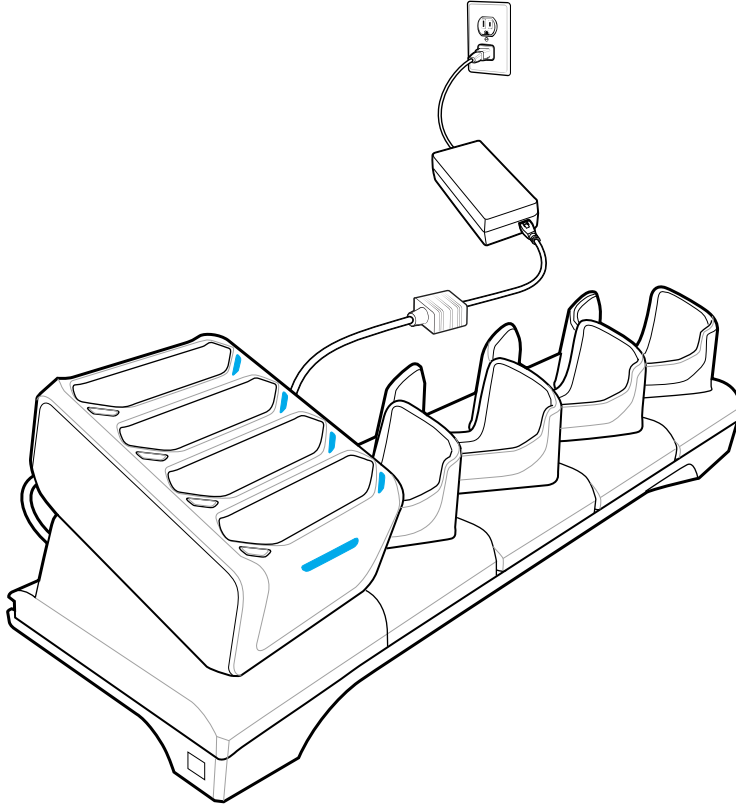
The 5-Slot Charge Only Cradle provides charging for up to five devices.



## Charging the Device with the 5-Slot Charge Only Cradle

1. Insert the device into a slot to begin charging.





2. Ensure the device is seated properly.

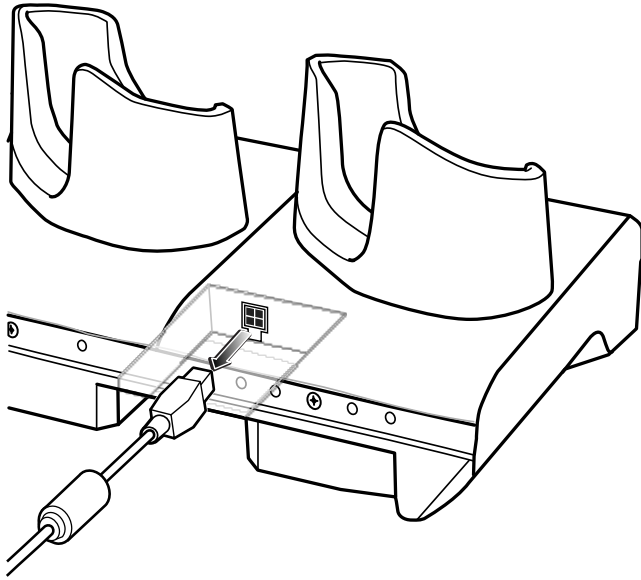
## Installing the Four Slot Battery Charger

Install the Four Slot Battery charger onto a 5-Slot Charge Only Cradle base. This provides a total for four device charging slots and four battery charging slots.

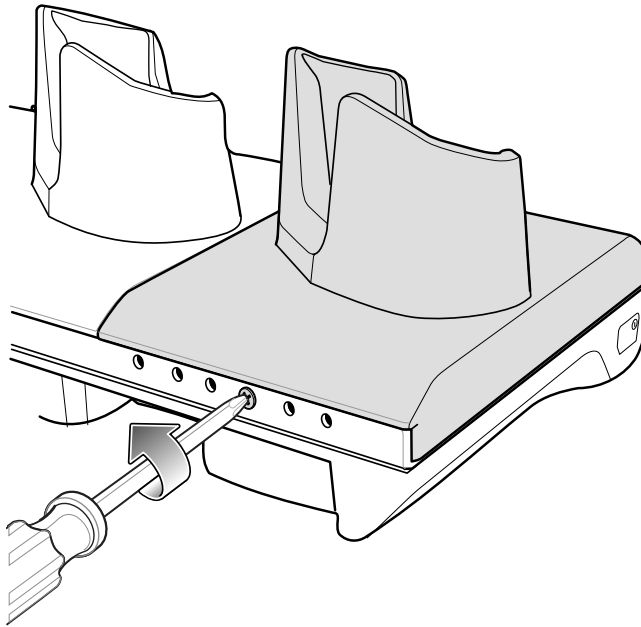


**NOTE:** The Battery Charger must be installed in the first slot only.

1. Remove power from the cradle.



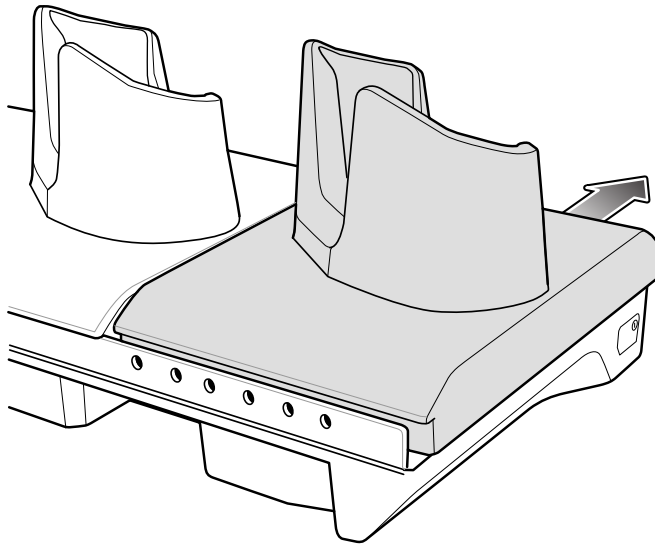
2. Using a Phillips screwdriver, remove the screw securing the cup to the cradle base.



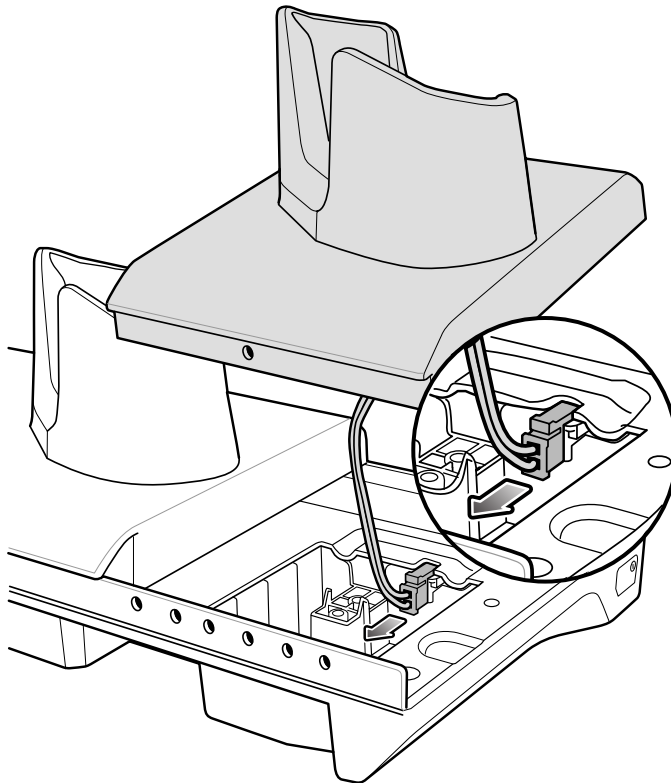


3. Slide the cup to the front of the cradle.

**Figure 38** Remove Cup

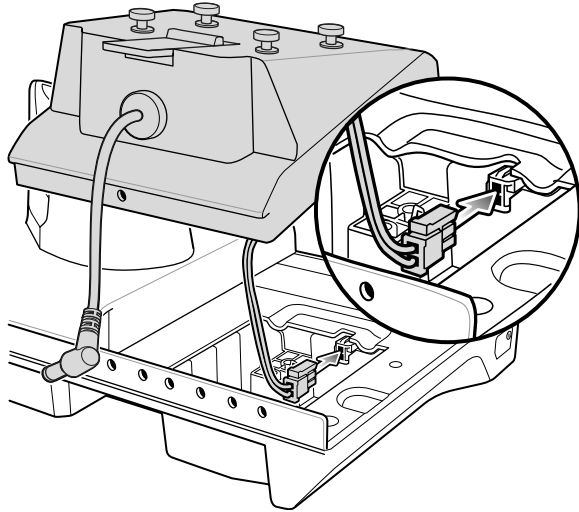


4. Carefully lift the cup up to expose the cup power cable.
5. Disconnect the cup power cable.

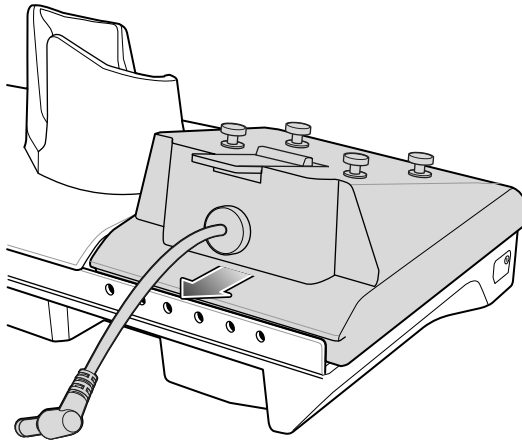


**NOTE:** Place power cable into adapter to avoid pinching cable.

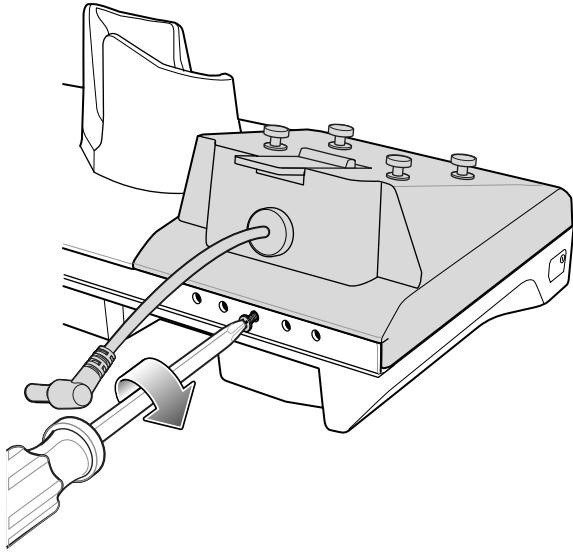
6. Connect the Battery Adapter power cable to the connector on the cradle.



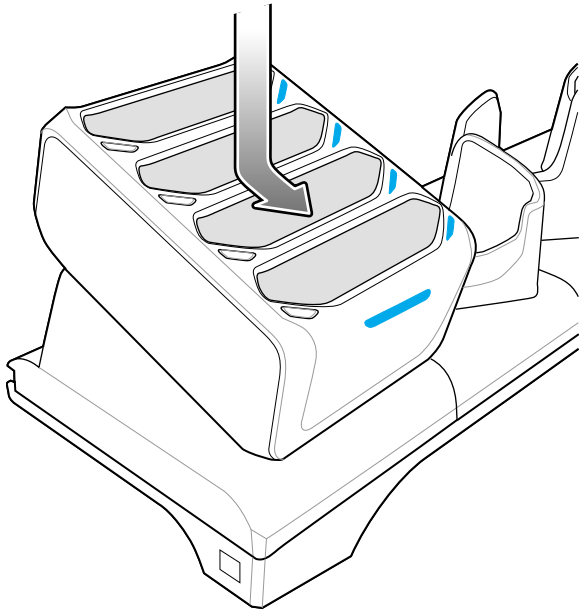
7. Place adapter onto cradle base and slide toward rear of cradle.



- Using a Phillips screwdriver, secure adapter to cradle base with screw.

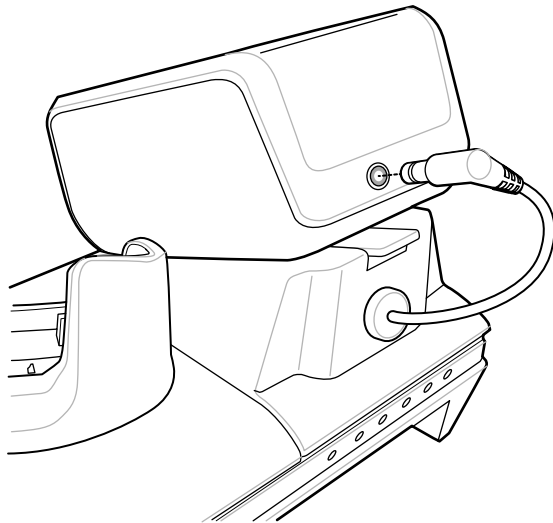


- Align mounting holes on the bottom of the Four Slot Battery Charger with the stubs on the Battery Adapter.



- Slide the Four Slot battery Charger down toward the front of the cradle.

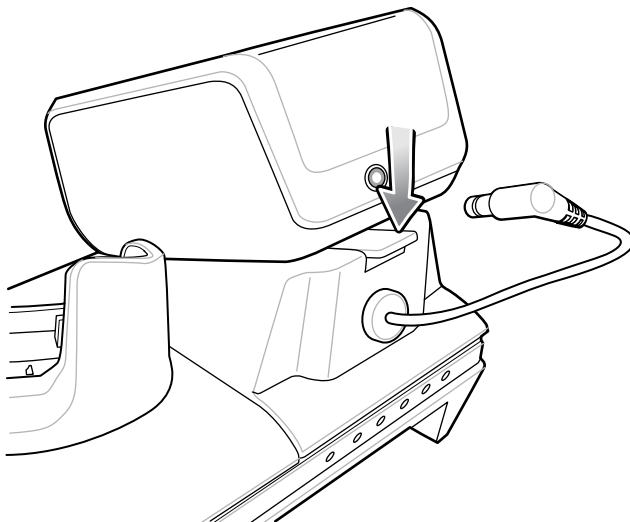
11. Connect the output power plug into the power port on the Four Slot Battery Charger.



## Removing the Four Slot Battery Charger

If necessary, you can remove the Four Slot Battery Charger from the 5-Slot Charge Only Cradle base.

1. Disconnect the output power plug from the 4-Slot Battery Charger.
2. At the back of the cup, press down on the release latch.



3. Slide the 4-Slot Battery Charger toward the front of the cradle.
4. Lift the 4-Slot off the cradle cup.

## 4-Slot Charge Only Cradle with Battery Charger

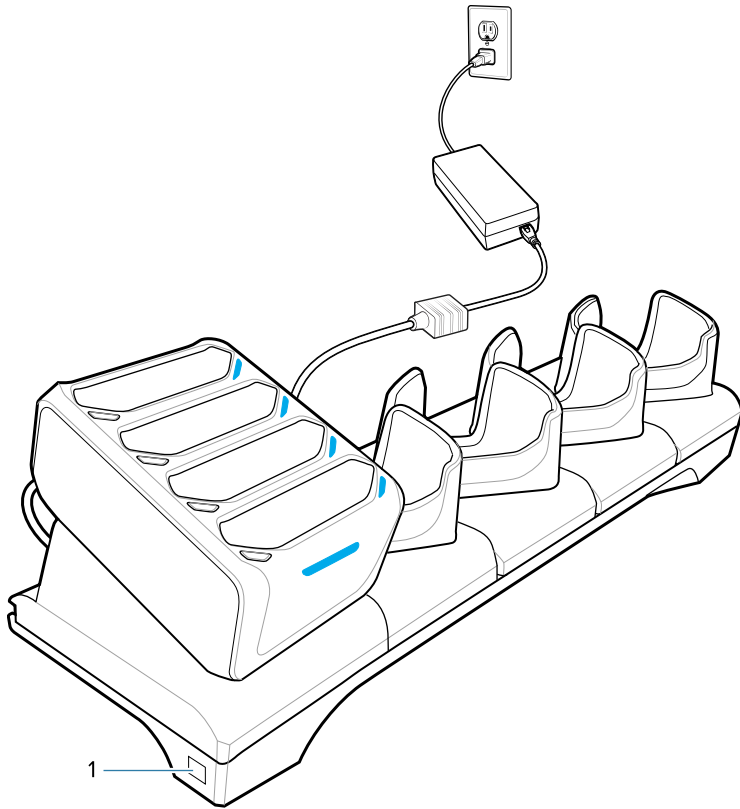


**CAUTION:** Ensure that you follow the guidelines for battery safety described in [Battery Safety Guidelines](#) on page 234.

The 4-Slot Charge Only Cradle with Battery Charger:

- Provides 5 VDC power for operating the device.
- Simultaneously charges up to four devices and up to four spare batteries.

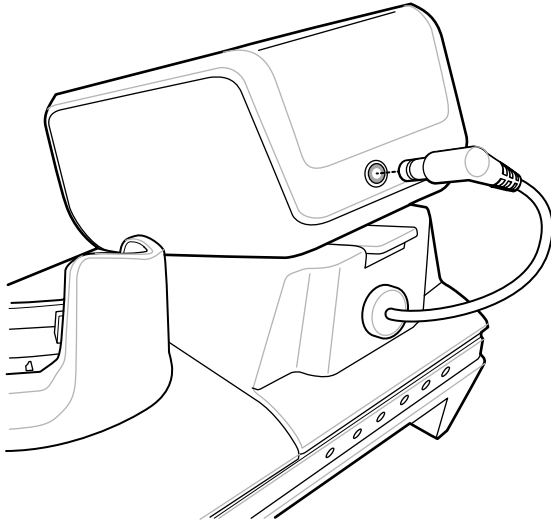
**Figure 39** 4-Slot Charge Only Cradle with Battery Charger



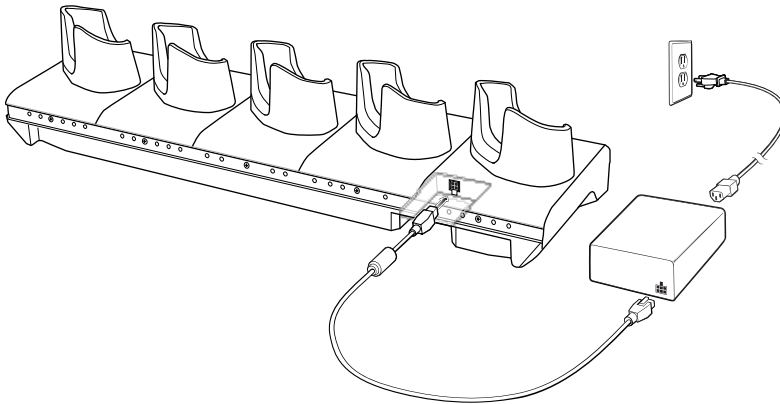
1	Power LED
---	-----------

## 4-Slot Charge Only Cradle with Battery Charger Setup

**Figure 40** Connect Battery Charger Output Power Plug



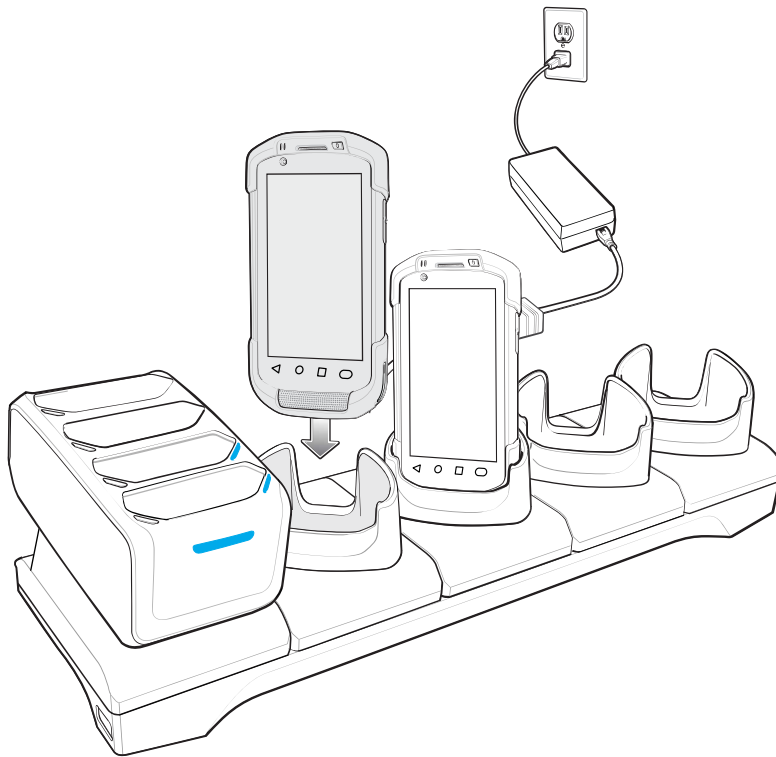
**Figure 41** Connect Charge Only Cradle Power



## Charging the Device with a 4-Slot Charge Only Cradle with Battery Charger

Use the 4-Slot Charge Only Cradle with Battery Charger to charge up to four devices and four spare batteries at the same time.

1. Insert the device into a slot to begin charging.



2. Ensure the device is seated properly.



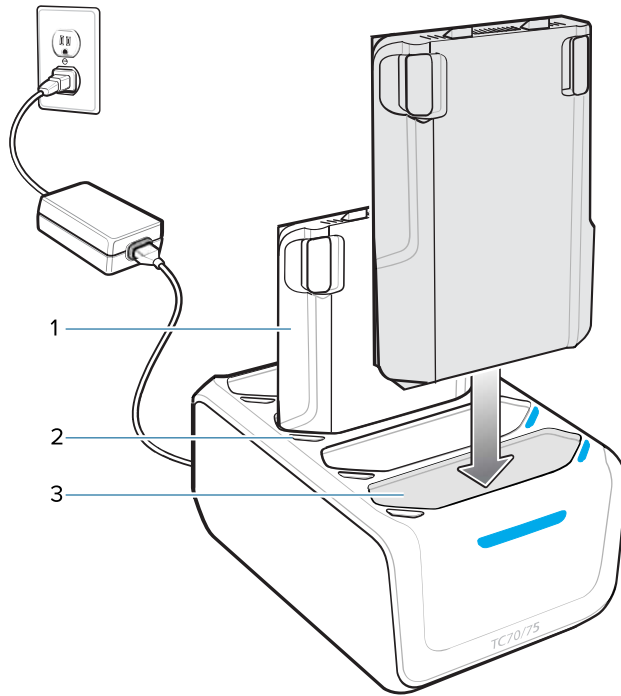
**NOTE:** See [Installing the Four Slot Battery Charger](#) on page 159 for information on installing the 4-Slot Battery Charger onto the cradle.

## Charging the Batteries with a 4-Slot Charge Only Cradle with Battery Charger

Use the 4-Slot Charge Only Cradle with Battery Charger to charge up to four devices and four spare batteries at the same time.

1. Connect the charger to a power source.

2. Insert the battery into a battery charging well and gently press down on the battery to ensure proper contact.



1	Battery
2	Battery charge LED
3	Battery slot

## 5-Slot Ethernet Cradle



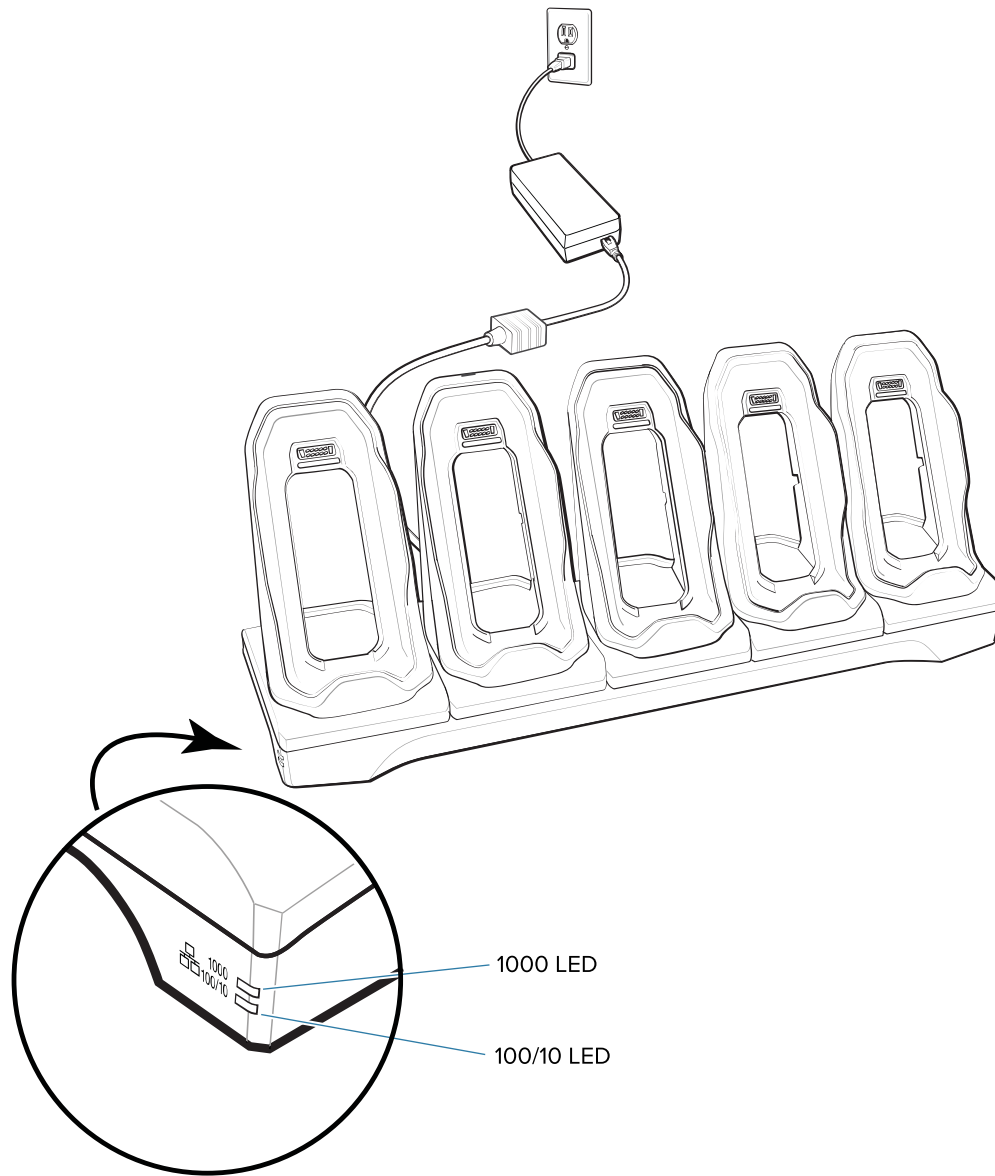
**CAUTION:** Ensure that you follow the guidelines for battery safety described in [Battery Safety Guidelines](#) on page 234.

The 5-Slot Ethernet Cradle:

- Provides 5.0 VDC power for operating the device.
- Connects up to five devices to an Ethernet network.
- Simultaneously charges up to five devices and up to four devices and on 4-Slot Battery Charger using the Battery Charger Adapter.

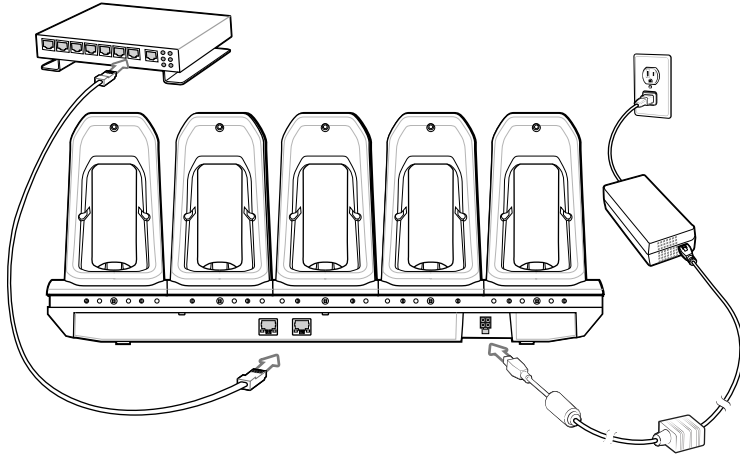


**Figure 42** 5-Slot Ethernet Cradle



## 5-Slot Ethernet Cradle Setup

Connect the 5-Slot Ethernet cradle to a power source.

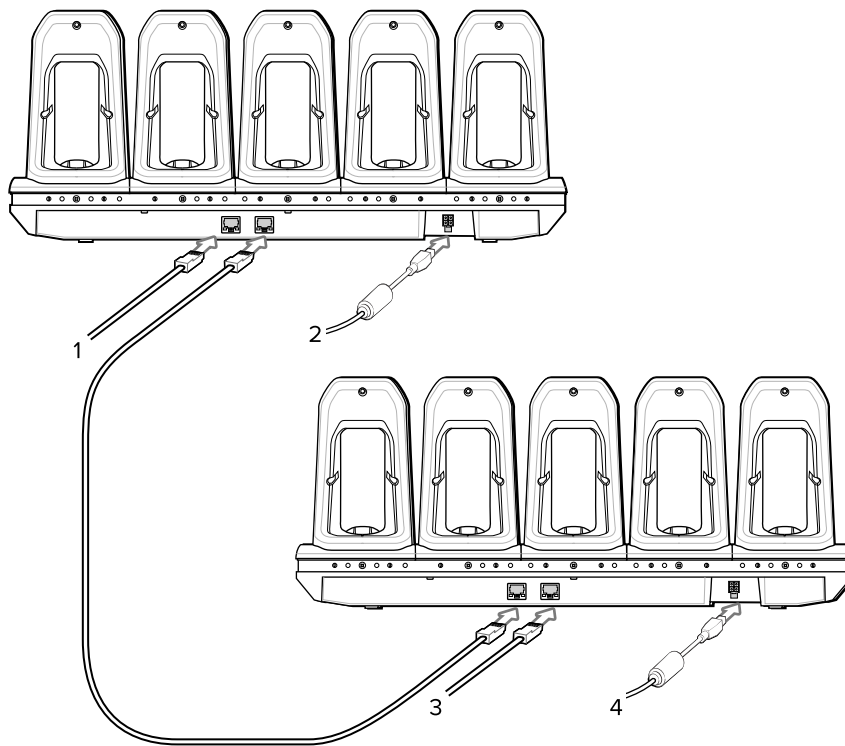


## Daisy-chaining Ethernet Cradles

Daisy-chain up to ten 5-Slot Ethernet cradles to connect several cradles to an Ethernet network.

Use either a straight or crossover cable. Daisy-chaining should not be attempted when the main Ethernet connection to the first cradle is 10 Mbps as throughput issues will almost certainly result.

1. Connect power to each 5-Slot Ethernet cradle.
2. Connect an Ethernet cable to the one of the ports on the back of the first cradle and to the Ethernet switch.
3. Connect the other end of the Ethernet cable to one of the ports of the back of the second 5-Slot Ethernet cradle.



1	To switch
---	-----------

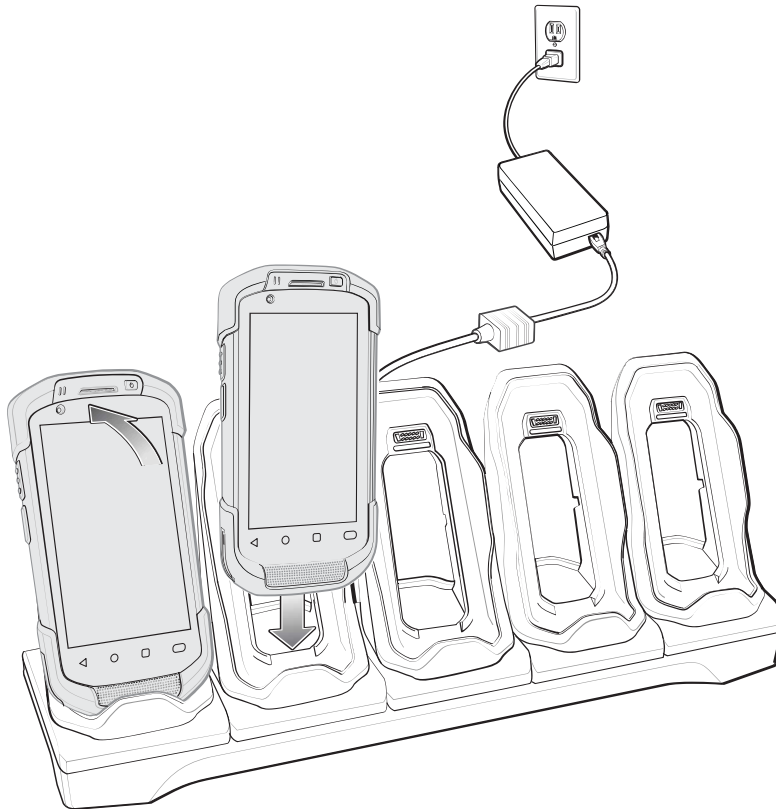
2	To power supply
3	To next cradle
4	To power supply

4. Connect additional cradles as described in step 2 and 3.

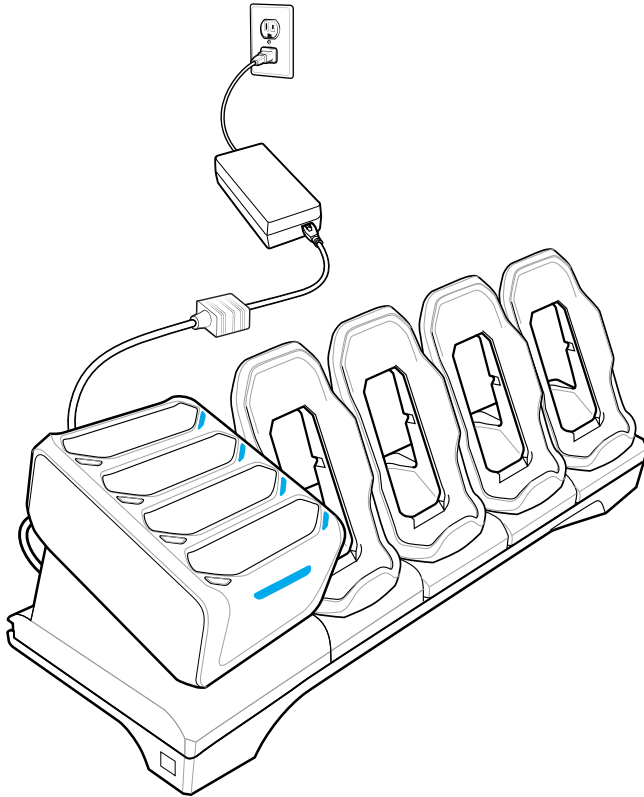
## Charging the Device with a 5-Slot Ethernet Cradle

Charge up to five Ethernet devices.

1. Insert the device into a slot to begin charging.



2. Ensure the device is seated properly.



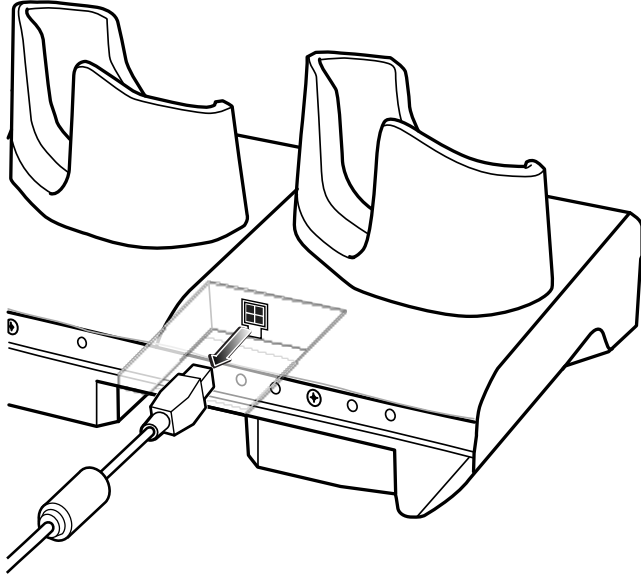
## Installing the Four Slot Battery Charger

Install the Four Slot Battery charger onto a 5-Slot Charge Only Cradle base. This provides a total for four device charging slots and four battery charging slots.

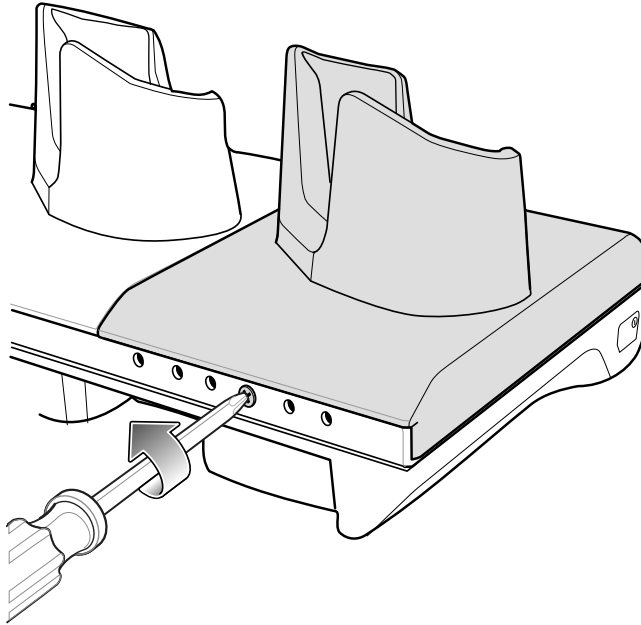


**NOTE:** The Battery Charger must be installed in the first slot only.

1. Remove power from the cradle.

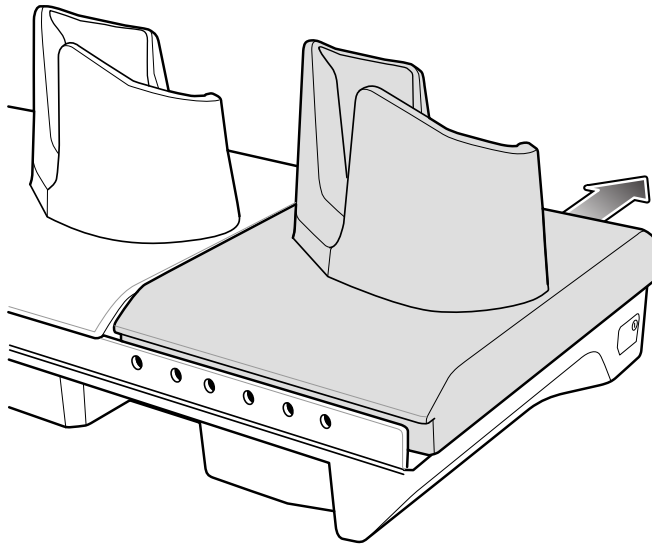


2. Using a Phillips screwdriver, remove the screw securing the cup to the cradle base.

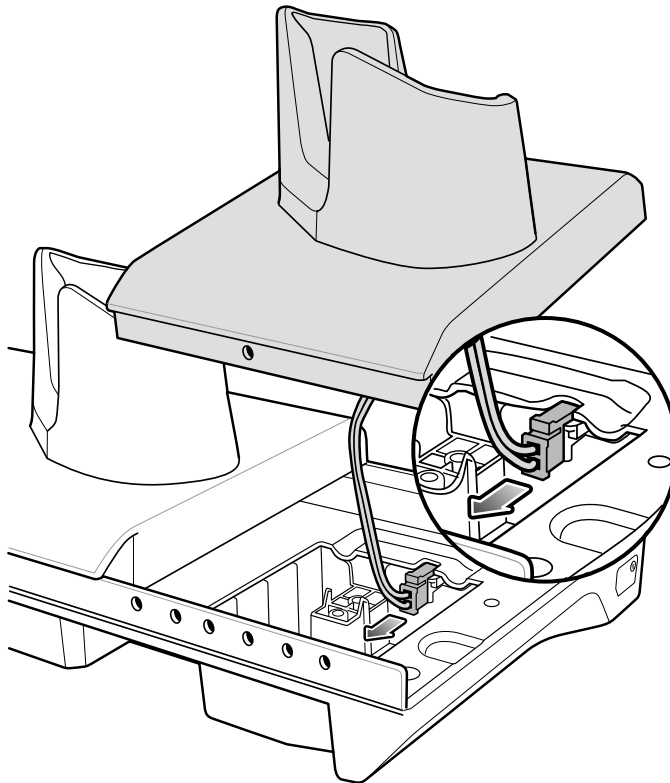


3. Slide the cup to the front of the cradle.

**Figure 43** Remove Cup

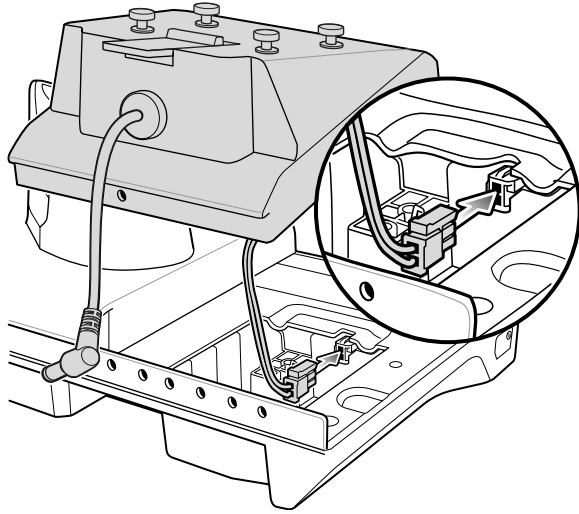


4. Carefully lift the cup up to expose the cup power cable.
5. Disconnect the cup power cable.

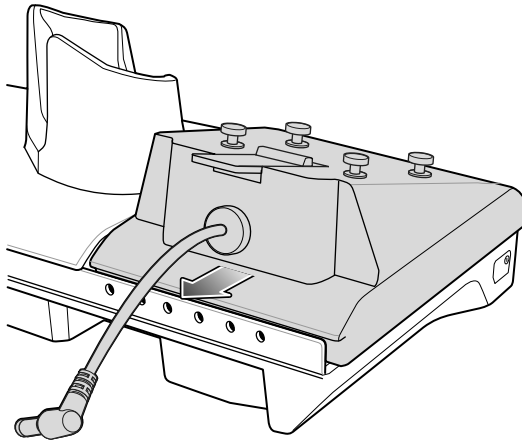


**NOTE:** Place power cable into adapter to avoid pinching cable.

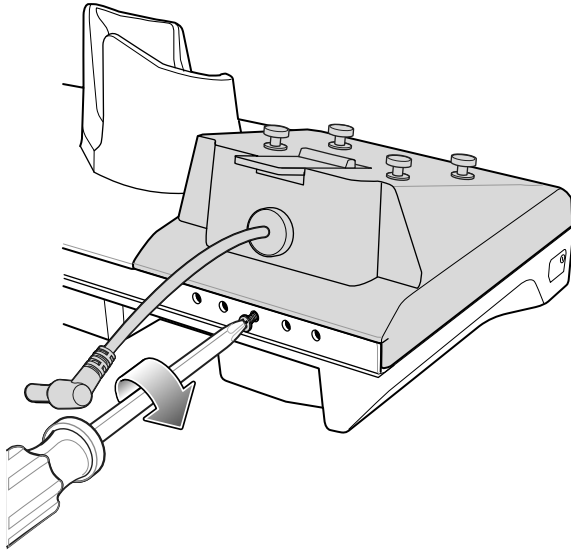
6. Connect the Battery Adapter power cable to the connector on the cradle.



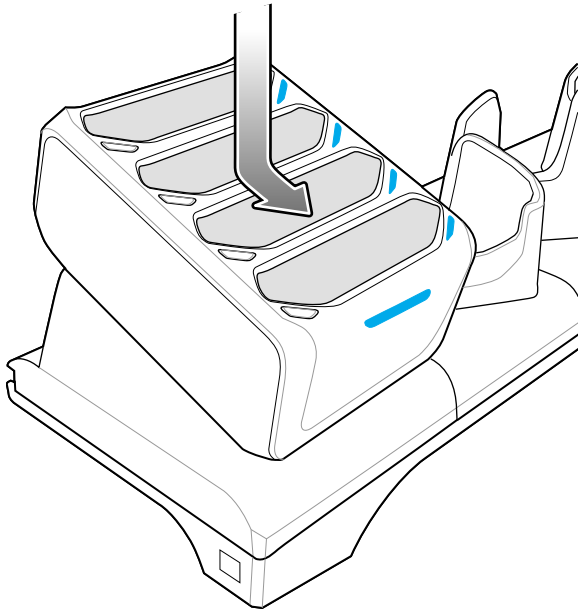
7. Place adapter onto cradle base and slide toward rear of cradle.



- Using a Phillips screwdriver, secure adapter to cradle base with screw.



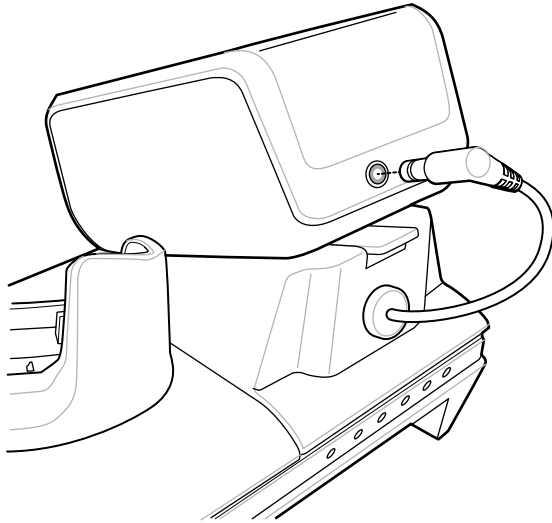
- Align mounting holes on the bottom of the Four Slot Battery Charger with the stubs on the Battery Adapter.



- Slide the Four Slot battery Charger down toward the front of the cradle.



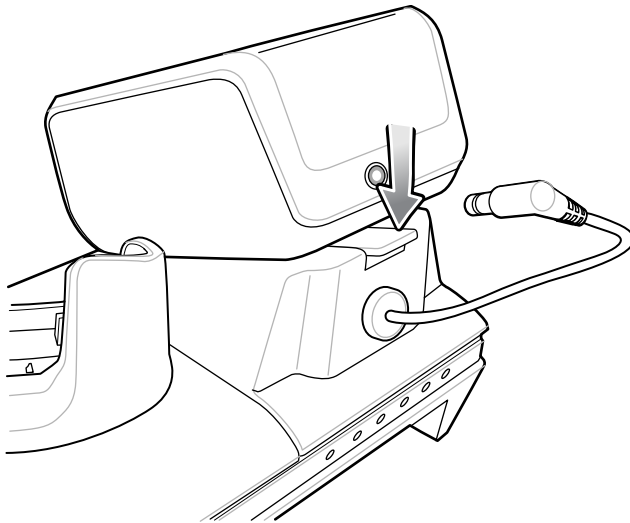
11. Connect the output power plug into the power port on the Four Slot Battery Charger.



### Removing the Four Slot Battery Charger

If necessary, you can remove the Four Slot Battery Charger from the 5-Slot Charge Only Cradle base.

1. Disconnect the output power plug from the 4-Slot Battery Charger.
2. At the back of the cup, press down on the release latch.



3. Slide the 4-Slot Battery Charger toward the front of the cradle.
4. Lift the 4-Slot off the cradle cup.

### Ethernet Communication

The 5-Slot Ethernet Cradle provides Ethernet communication with a network.

## Ethernet LED Indicators


There are two green LEDs on the side of the cradle. These green LEDs light and blink to indicate the data transfer rate.

**Table 29** LED Data Rate Indicators

Data Rate	1000 LED	100/10 LED
1 Gbps	On/Blink	Off
100 Mbps	Off	On/Blink
10 Mbps	Off	On/Blink

## Establishing Ethernet Connection

1. Go to **Settings**.
2. Touch **Network & internet**>**Ethernet**.
3. Slide the Ethernet switch to the **ON** position.
4. Insert the device into a slot.

The  icon appears in the Status bar.

5. Touch **Eth0** to view Ethernet connection details.

## Configuring Ethernet Proxy Settings

The device includes Ethernet cradle drivers. After inserting the device, configure the Ethernet connection.

1. Go to **Settings**.
2. Touch **Network & internet**>**Ethernet**.
3. Place the device into the Ethernet cradle slot.
4. Slide the switch to the **ON** position.
5. Touch and hold **Eth0** until the menu appears.
6. Touch **Modify Proxy**.
7. Touch the **Proxy** drop-down list and select **Manual**.
8. In the **Proxy hostname** field, enter the proxy server address.
9. In the **Proxy port** field, enter the proxy server port number.



**NOTE:** When entering proxy addresses in the Bypass proxy for field, do not use spaces or carriage returns between addresses.

10. In the **Bypass proxy for** text box, enter addresses for web sites that do not require to go through the proxy server. Use the separator “|” between addresses.
11. Touch **MODIFY**.
12. Touch Home.

## Configuring Ethernet Static IP Address

The device includes Ethernet cradle drivers. After inserting the device, configure the Ethernet connection:

1. Go to **Settings**.
2. Touch **Network & internet**>**Ethernet**.
3. Place the device into the Ethernet cradle slot.
4. Slide the switch to the **ON** position.
5. Touch **Eth0**.
6. Touch **Disconnect**.
7. Touch **Eth0**.
8. Touch and hold the IP settings drop-down list and select **Static**.
9. In the **IP** address field, enter the proxy server address.
10. If required, in the **Gateway** field, enter a gateway address for the device.
11. If required, in the **Netmask** field, enter the network mask address
12. If required, in the **DNS address** fields, enter a Domain Name System (DNS) addresses.
13. Touch **CONNECT**.
14. Touch Home.

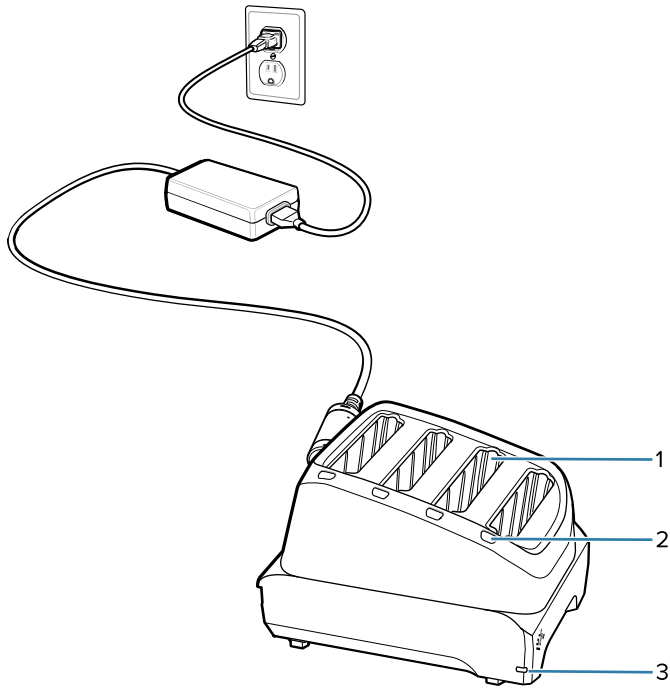
## 4-Slot Battery Charger

This section describes how to use the 4-Slot Battery Charger to charge up to four device batteries.



**CAUTION:** Ensure that you follow the guidelines for battery safety described in [Battery Safety Guidelines](#) on page 234.

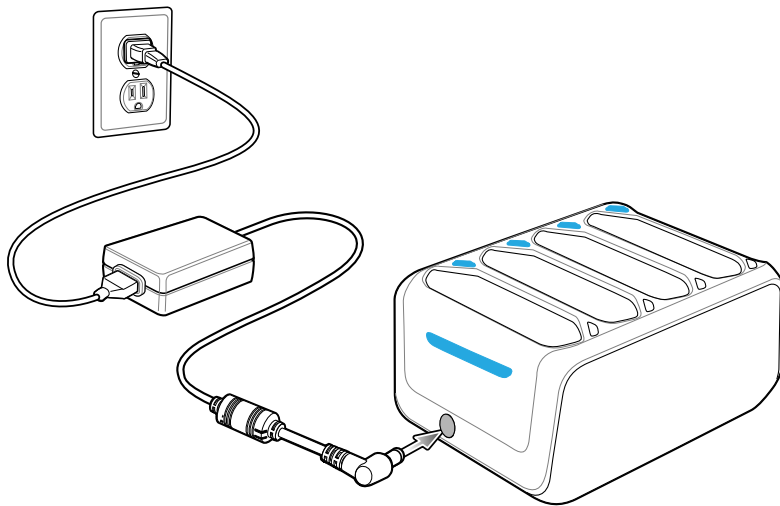
**Figure 44** 4-Slot Battery Charger



1	Battery Slot
2	Battery Charging LED
3	Power LED

## 4-Slot Battery Charger Setup

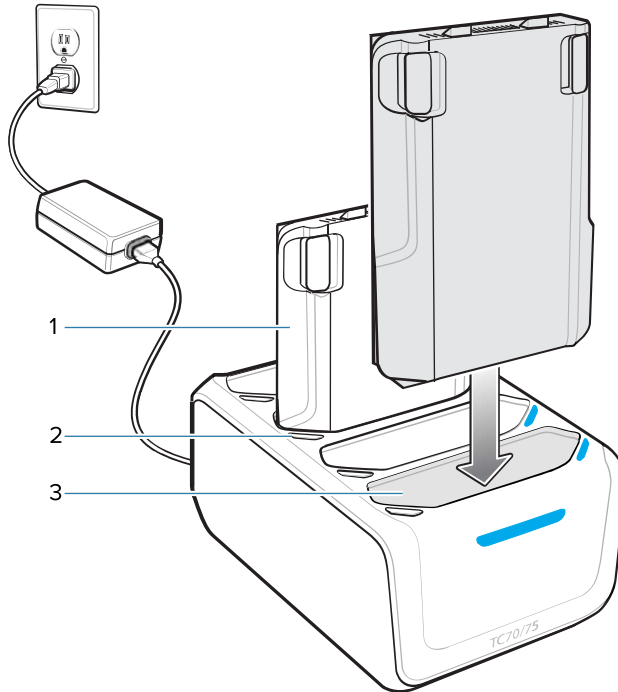
**Figure 45** Four Slot Battery Charger Power Setup



## Charging Spare Batteries in the 4-Slot Battery Charger

Charge up to four spare batteries.

1. Connect the charger to a power source.
2. Insert the battery into a battery charging well and gently press down on the battery to ensure proper contact.



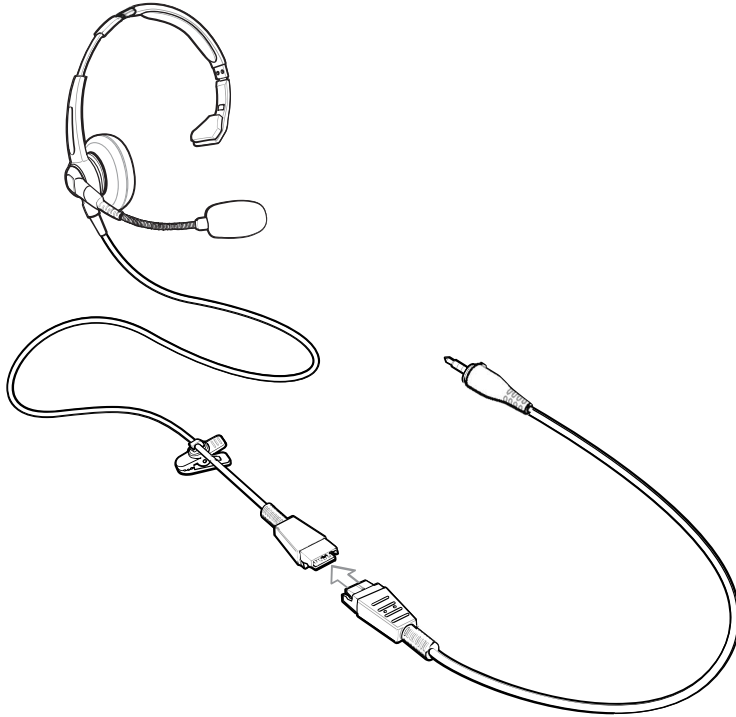
1	Battery
2	Battery charge LED
3	Battery slot

## 3.5 mm Audio Adapter

The 3.5 mm Audio Adapter snaps onto the back of the device and removes easily when not in use. When attached to the device the 3.5 mm Audio Adapter allows a user to connect a wired headset to the device.

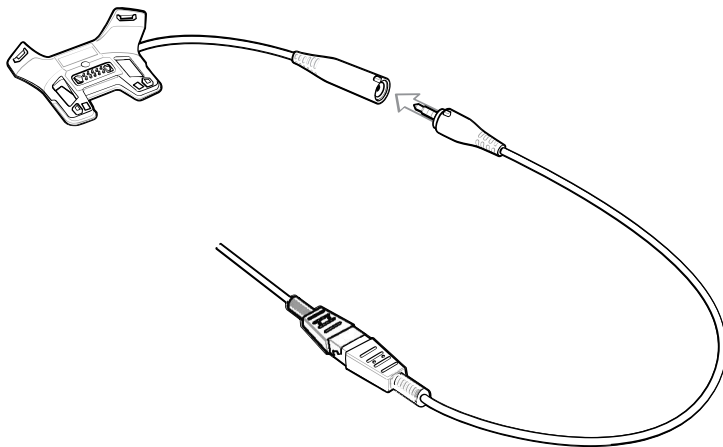
## Connecting a Headset to the 3.5 mm Audio Adapter

1. Connect the Quick Disconnect connect of the headset to the Quick Disconnect connector of the 3.5 mm Quick Disconnect Adapter Cable.



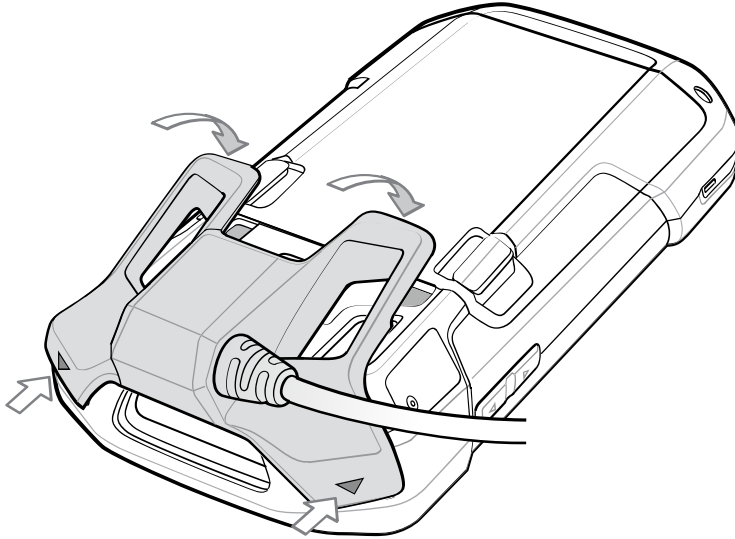
2. Connect the audio jack of the 3.5 mm Quick Disconnect Adapter Cable to the 3.5 mm Audio Adapter.

**Figure 46** Connect Adapter Cable to Audio Adapter



## Attaching the 3.5 mm Audio Adapter

1. Align the top mounting points on the 3.5 mm Audio Adapter with the mounting slots on the device.

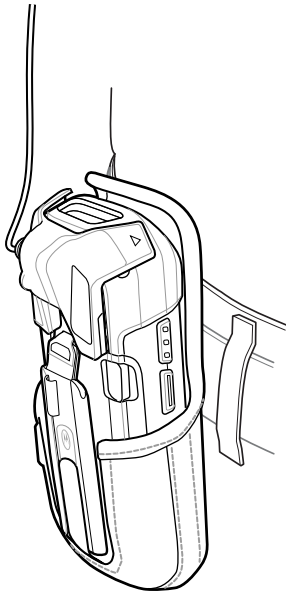


2. Rotate the Audio Adapter down and press down until it snaps into position.

## Device with 3.5 mm Audio Adapter in Holster

When using the device and the audio adapter in a holster, ensure that the display faces in and the headset cable is securely attached to the audio adapter.

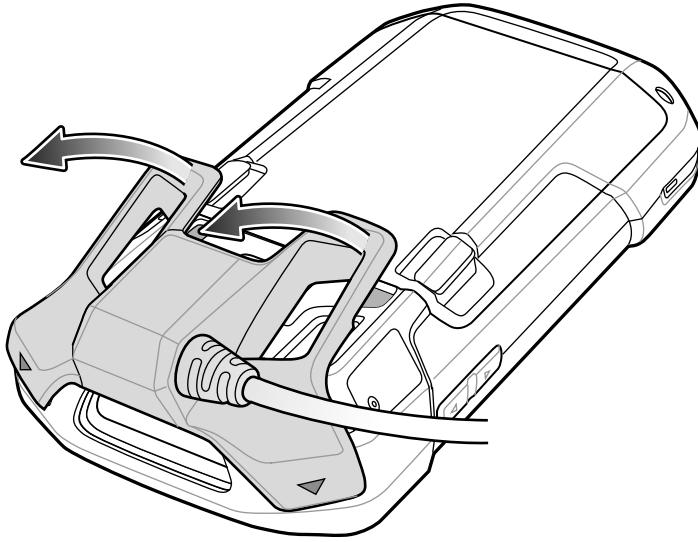
**Figure 47** Device with 3.5 mm Audio Adapter in Holster



## Removing the 3.5 mm Audio Adapter

1. Disconnect headset plug from 3.5 mm Audio Adapter.

2. Lift the bottom of the Audio Adapter away from the device.



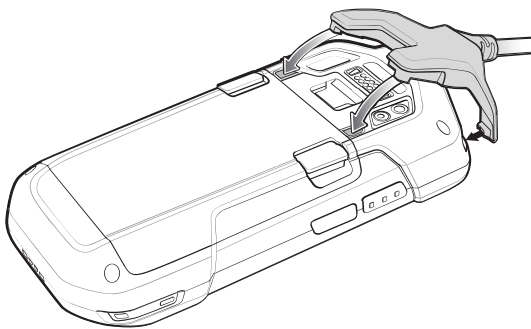
3. Remove Audio Adapter from the device.

## Snap-On USB Cable

The Snap-On USB Cable snaps on to the back of the device and removes easily when not in use. When attached to the device the Snap-On USB Cable allows the device to transfer data to a host computer and provide power for charging the device.

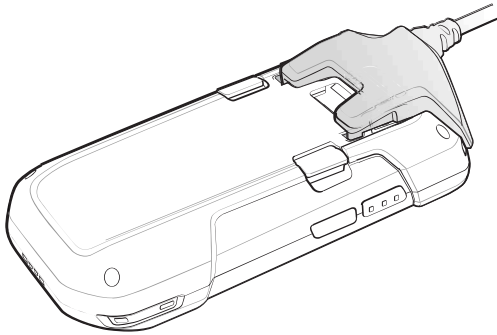
### Attaching the Snap-On USB Cable

1. Align the top mounting points on the cable with the mounting slots on the device.



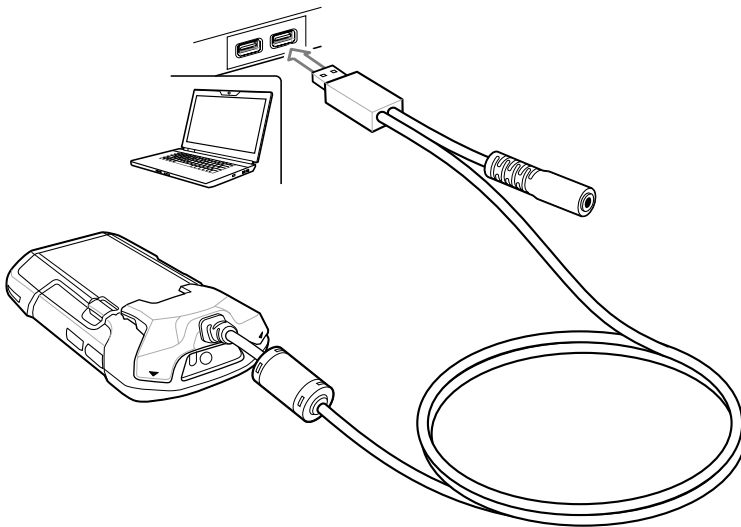


2. Rotate the cable down and press until it snaps into place. Magnetics hold the cable to the device.



## Connecting the Snap-On USB Cable to a Computer

1. Connect the Snap-On USB Cable to the device.

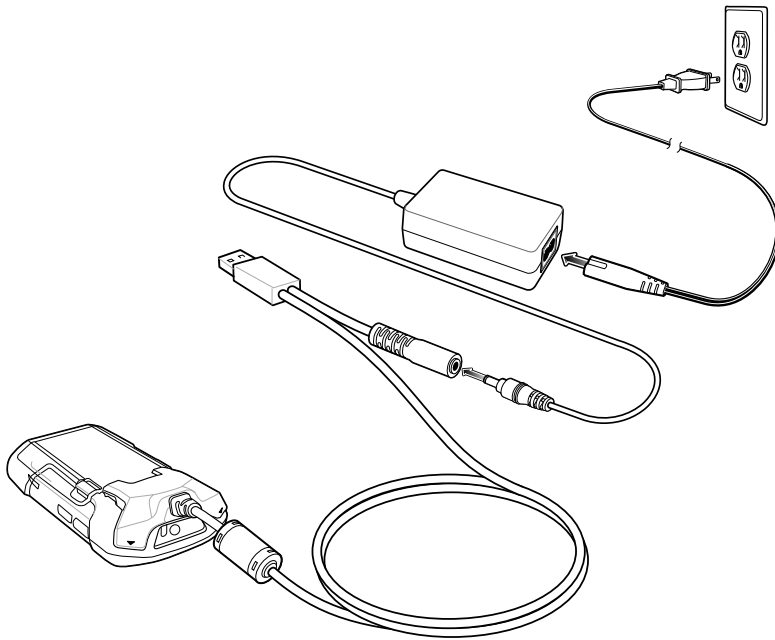


2. Connect the USB connector of the cable to a host computer.

## Charging the Device with the Snap-On USB Cable

1. Connect the Snap-On USB Cable to the device.

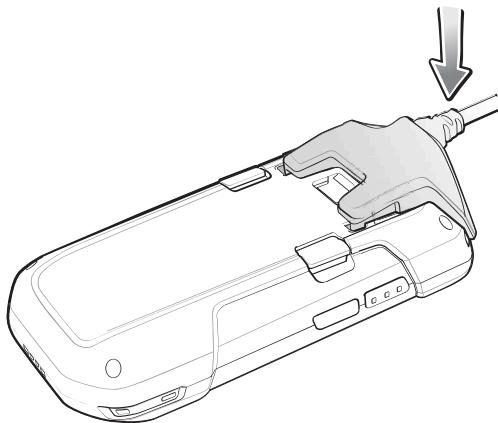
2. Connect the power supply to the Snap-On USB Cable



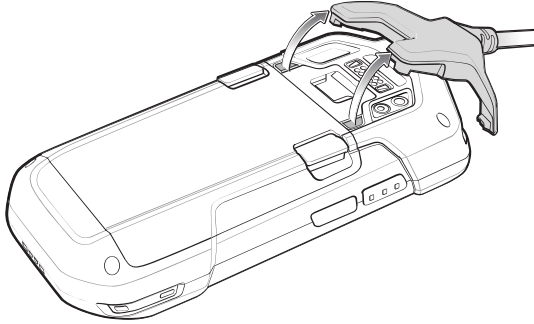
3. Connect to the power supply to an AC outlet.

## Removing the Snap-On USB Cable from the Device

1. Press down on the cable.



2. Rotate away from the device. The magnetics release the cable from the device.

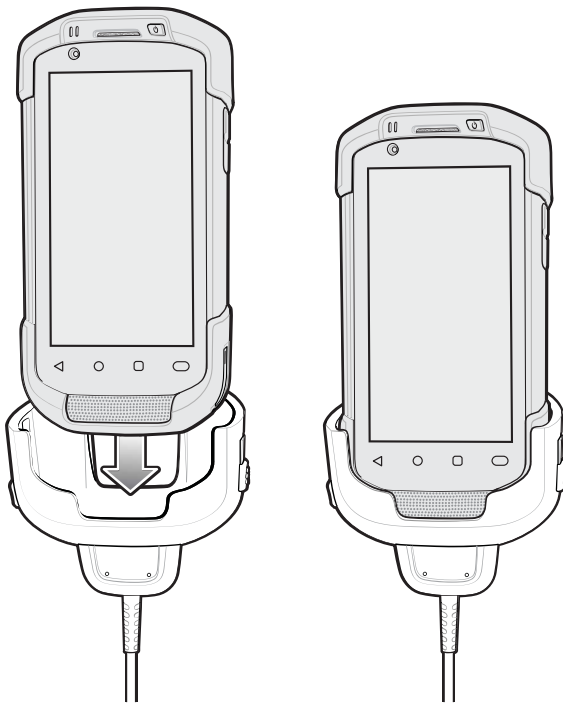


## Charging Cable Cup

Use the Charging Cable Cup to charge the device.

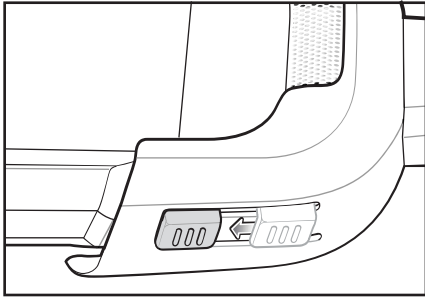
### Charging the Device with the Charging Cable Cup

1. Insert the device into the cup of the Charging Cable Cup.

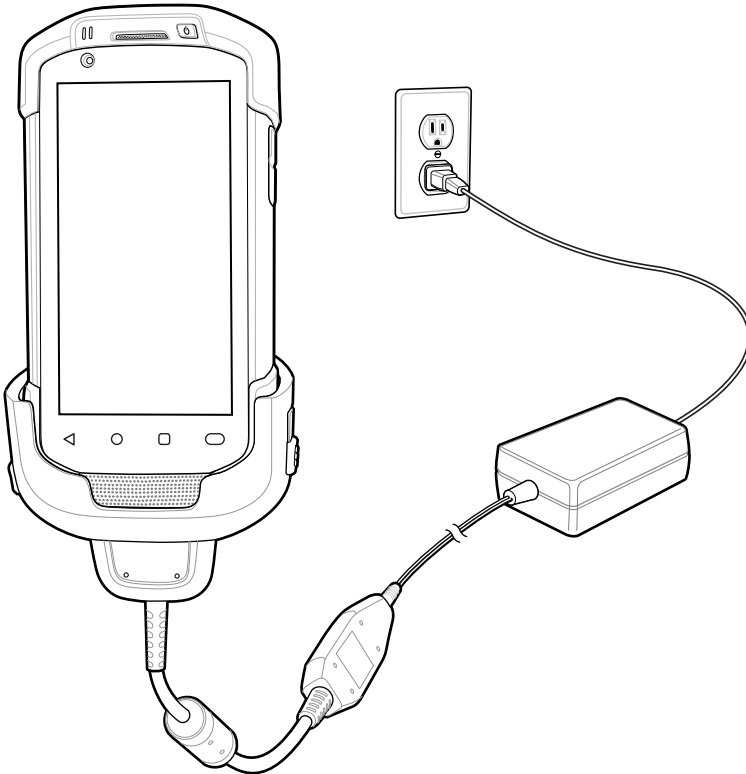


2. Ensure the device is seated properly.

3. Slide the two yellow locking tabs up to lock the cable to the device.



4. Connect the power supply to the Charging Cable Cup and to a power source.

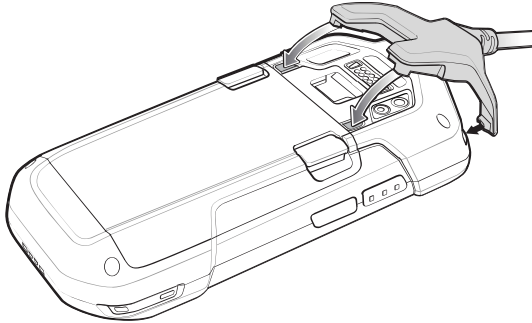


## Snap-On DEX Cable

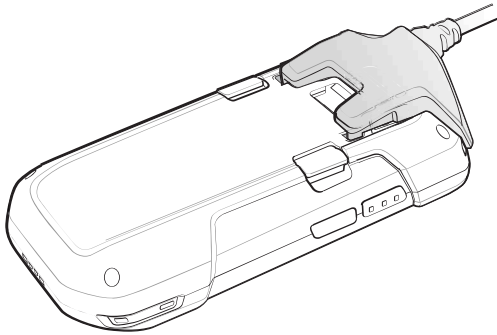
The Snap-On DEX Cable snaps on to the back of the device and removes easily when not in use. When attached to the device the Snap-On DEX Cable provides electronic data exchange with devices such as vending machines.

### Attaching the Snap-On DEX Cable

1. Align the top mounting points on the cable with the mounting slots on the device.



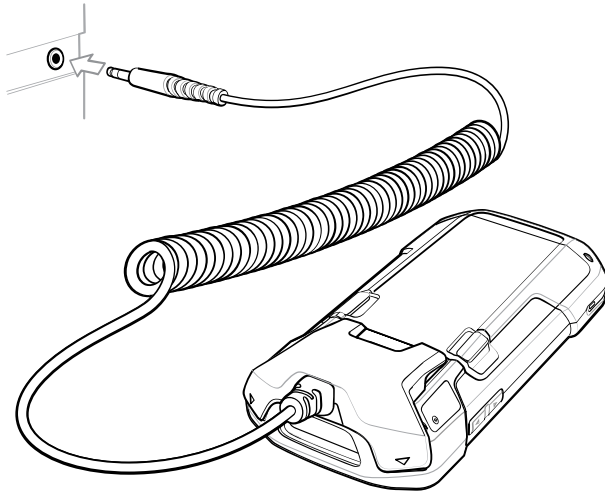
2. Rotate the cable down and press until it snaps into place. Magnetics hold the cable to the device.



### Connecting the Snap-On DEX Cable

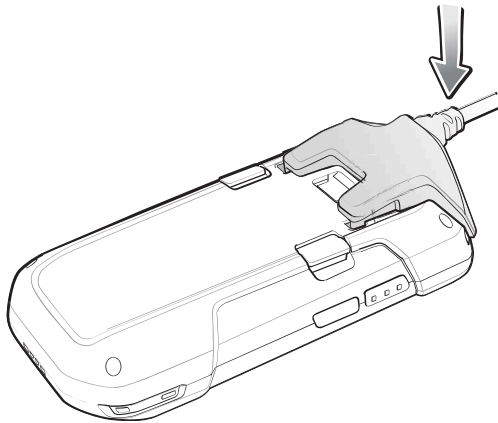
1. Connect the Snap-On DEX Cable to the device.

2. Connect the DEX connector of the cable to a device such as a vending machine.

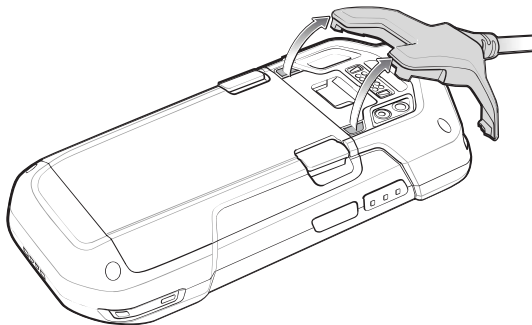


### Disconnecting the Snap-On DEX Cable from the Device

1. Press down on the cable.



2. Rotate away from the device. The magnetics release the cable from the device.



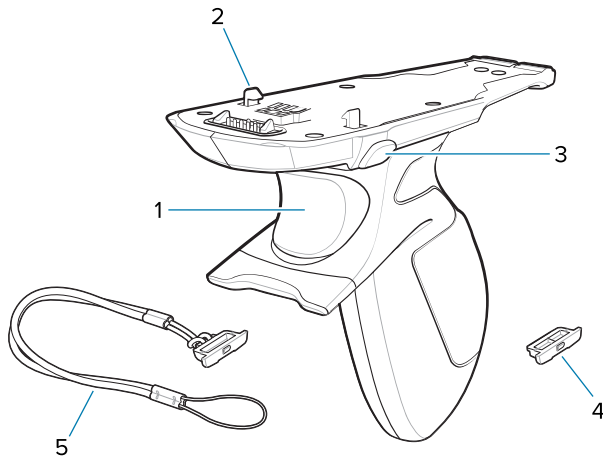
## Trigger Handle

The Trigger Handle adds a gun-style handle with a scanning trigger to the device. It increases comfort when using the device in scan-intensive applications for extended periods of time.



**NOTE:** The Attachment Plate with Tether can only be used with Charge Only cradles.

**Figure 48** Trigger Handle



1	Trigger
2	Latch
3	Release button
4	Attachment plate without tether
5	Attachment plate with tether

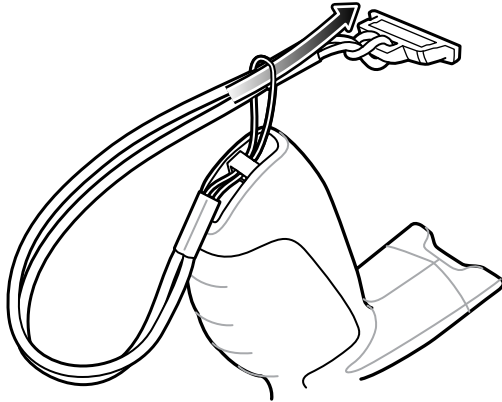
### Installing the Attachment Plate to Trigger Handle



**NOTE:** Attachment Plate with Tether only.

1. Insert the loop end of the tether into the slot on the bottom of the handle.

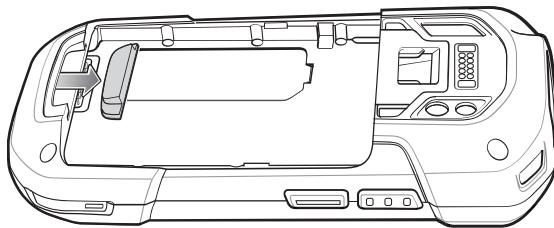
2. Feed the attachment plate through the loop.



3. Pull the attachment plate until the loop tightens on the tether.

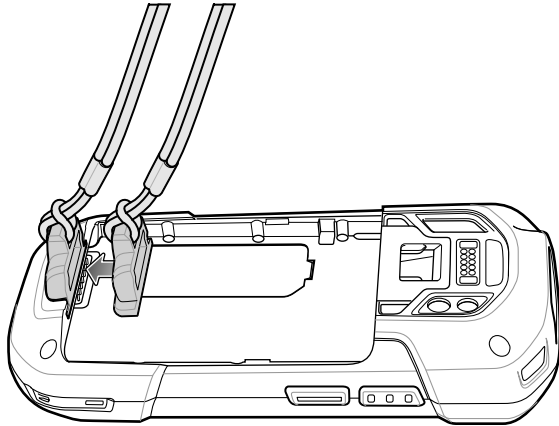
## Installing the Trigger Handle Plate

1. Press and hold the **Power** button until the menu appears.
2. Touch **Power off**.
3. Touch **OK**.
4. Press in the two battery latches.
5. Lift the battery from the device.
6. Remove the hand strap filler plate from the hand strap slot. Store the hand strap filler plate in a safe place for future replacement.





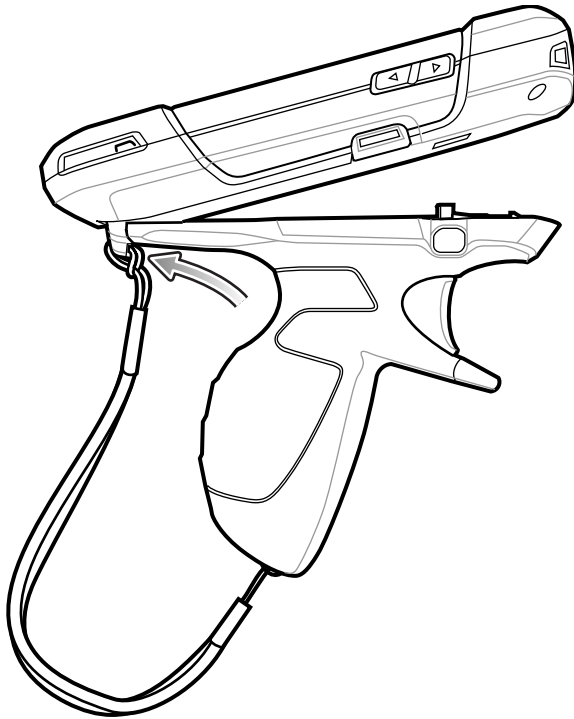
7. Insert the attachment plate into the hand strap slot.



8. Insert the battery, bottom first, into the battery compartment in the back of the device.
9. Rotate the top of the battery into the battery compartment.
10. Press the battery down into the battery compartment until the battery release latches snap into place.

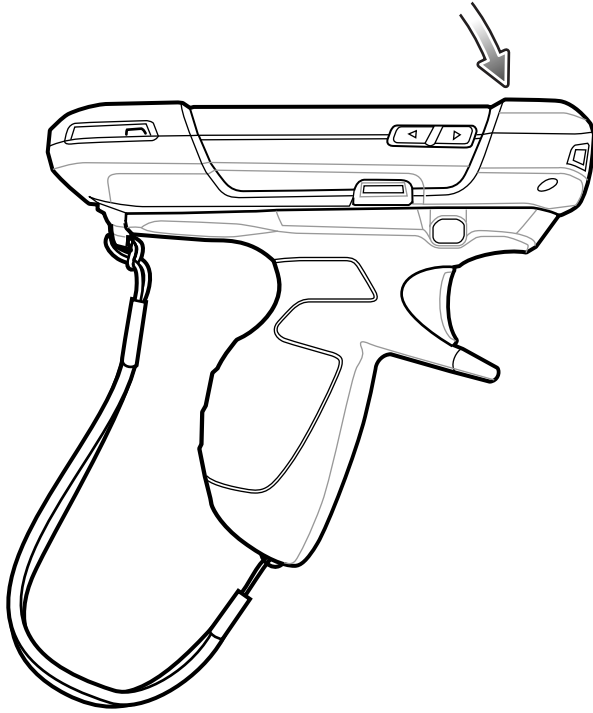
## Inserting the Device into the Trigger Handle

1. Align the back of the Trigger handle with the Trigger Mounting Plate.



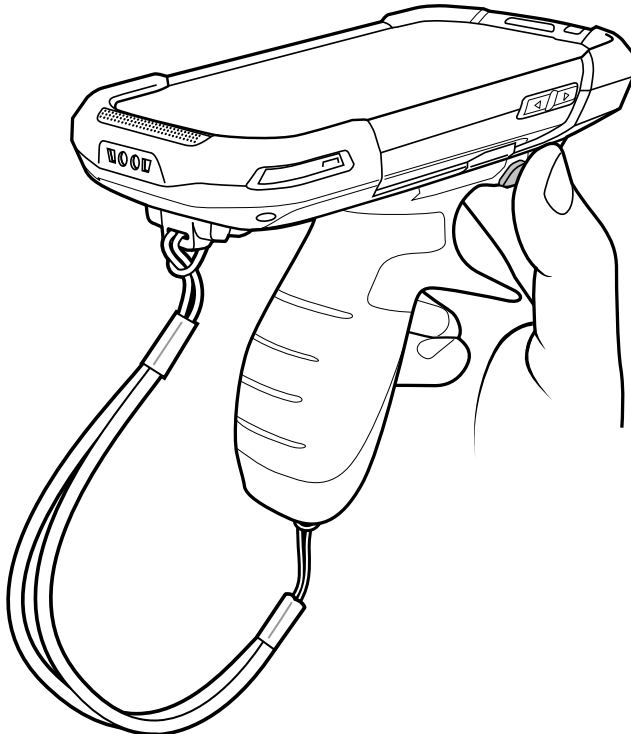
2. Press the two release latches.

3. Rotate the device down and press down until it snaps into place.

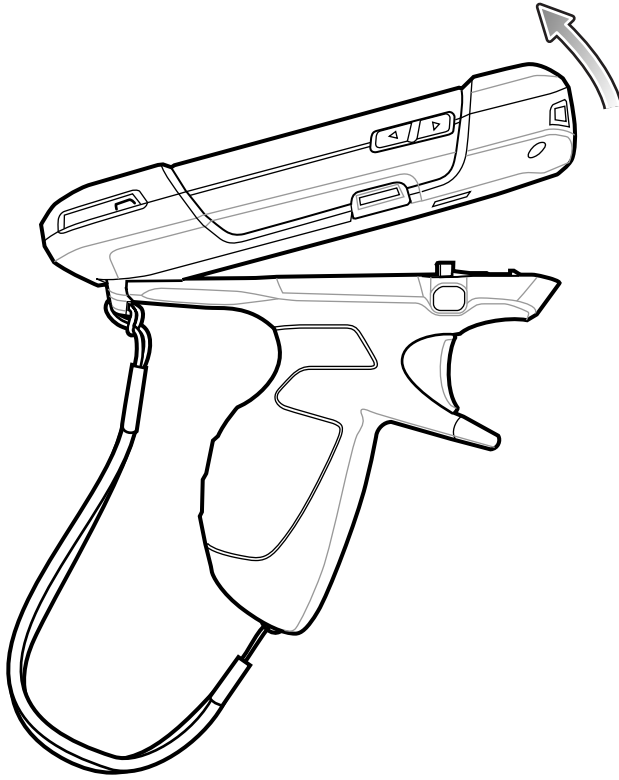


### Removing the Device from the Trigger Handle

1. Press both Trigger Handle release latches.

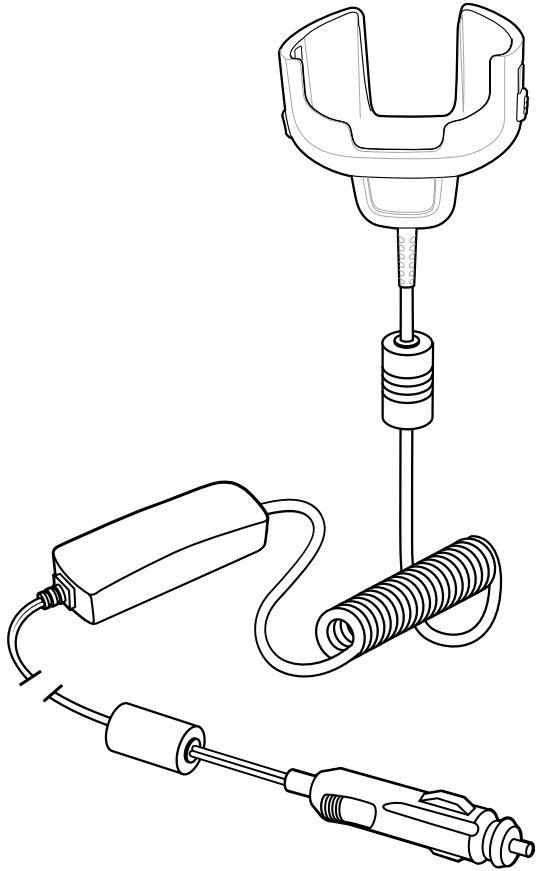


2. Rotate the device up and remove from the Trigger handle.



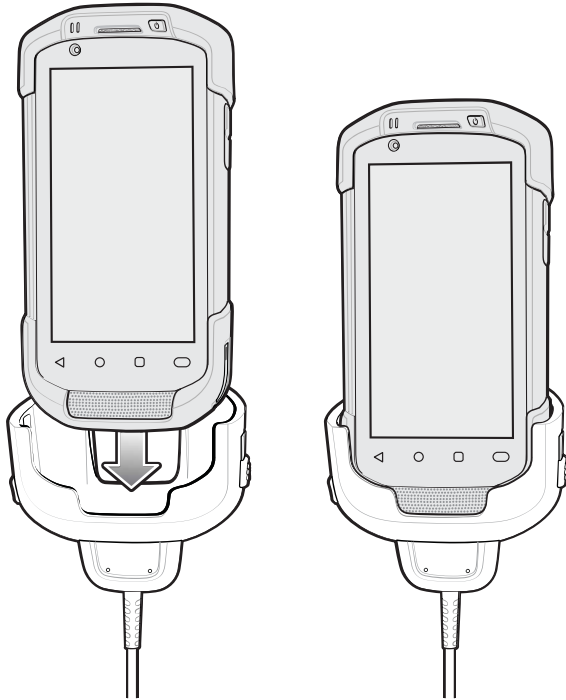
## Vehicle Charging Cable Cup

This section describes how to use the Vehicle Charging Cable Cup to charge the device.

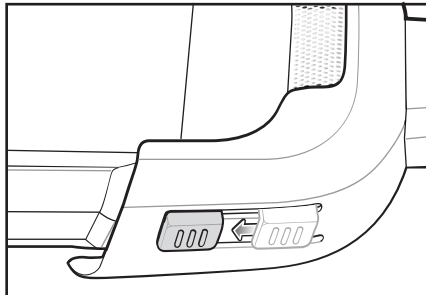


## Charging the Device with the Vehicle Charging Cable

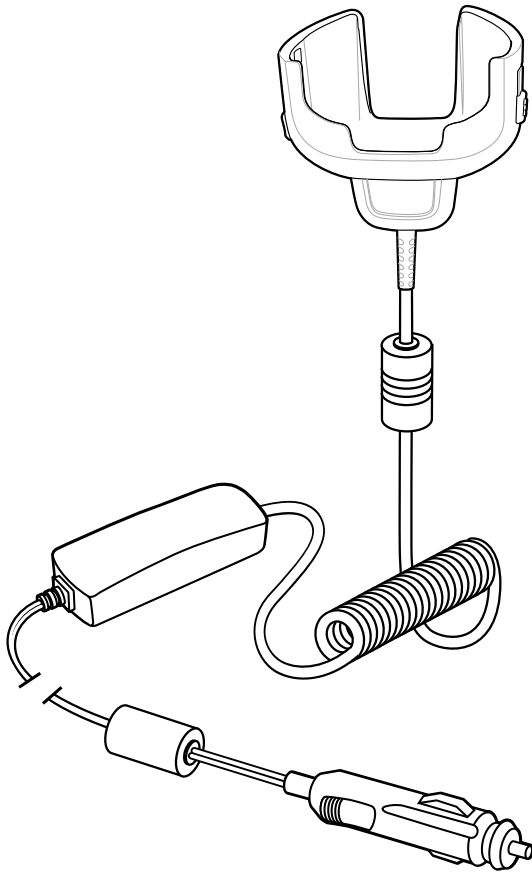
1. Insert the device into the cup of the Vehicle Charging Cable.



2. Ensure the device is seated properly.
3. Slide the two yellow locking tabs up to lock the cable to the device.



4. Insert the Cigarette Lighter plug into the vehicle cigarette lighter socket.



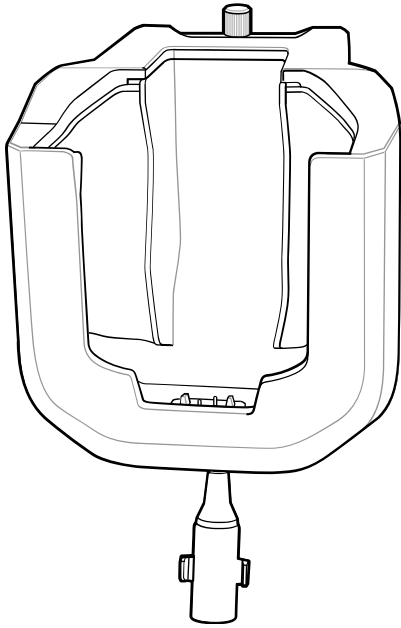
## Vehicle Cradle

The cradle:

- Holds the device securely in place
- Provides power for operating the device
- Re-charges the battery in the device.

The cradle is powered by the vehicle's 12V or 24V electrical system. The operating voltage range is 9V to 32V and supplies a maximum current of 3A.

**Figure 49** Vehicle Cradle



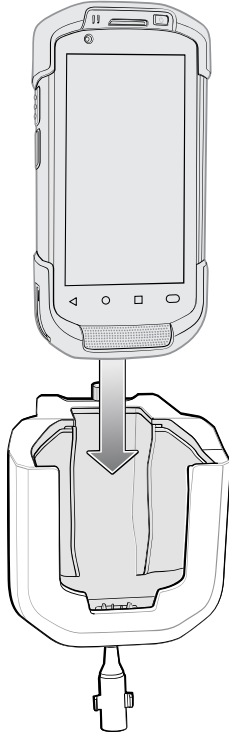
## Inserting the Device into the Vehicle Cradle



**CAUTION:** Ensure that the device is fully inserted into the cradle. Lack of proper insertion may result in property damage or personal injury. Zebra Technologies Corporation is not responsible for any loss resulting from the use of the products while driving.

- To ensure the device was inserted correctly, listen for the audible click that signifies that the device locking mechanism was enabled and the device was locked into place.

**Figure 50** Install Device into Vehicle Cradle

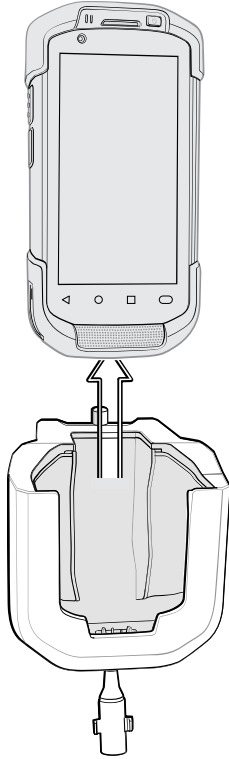




## Removing the Device from the Vehicle Cradle

- To remove the device from the cradle, grasp the device and lift out of the cradle.

**Figure 51** Remove Device from Vehicle Cradle



## Charging the Device in the Vehicle Cradle

1. Ensure the cradle is connected to a power source.
2. Insert the device into the cradle.

The device starts to charge through the cradle as soon as it is inserted. This does not deplete the vehicle battery significantly. The battery charges in approximately four hours. See [Charging Indicators](#) on page 31 for charging indications.



**NOTE:** The Vehicle Cradle operating temperature is -40°C to +85°C. When in the cradle, the device will only charge when its temperature is between 0°C to +40°C.

## TC7X Vehicle Communication Charging Cradle

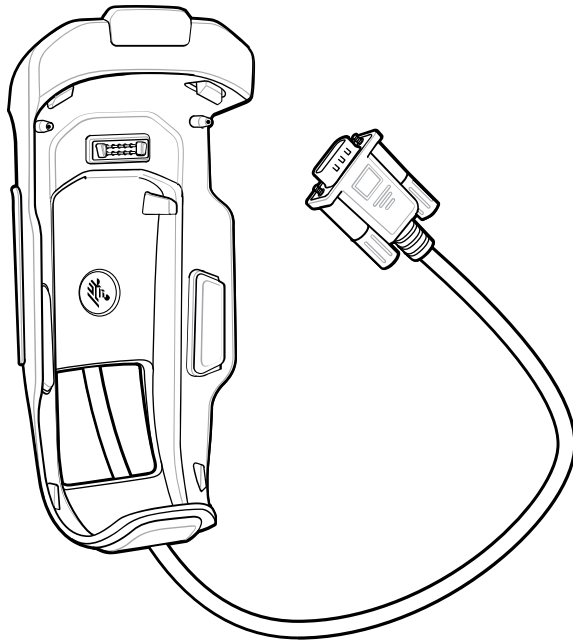
The Vehicle Communication Charging Cradle:

- holds the device securely in place
- provides power for operating the device
- re-charges the battery in the device.

The cradle is powered by the USB I/O Hub.

Refer to the TC7X Vehicle Cradle Installation Guide for information on installing the TC7X Vehicle Communication Charging Cradle.

**Figure 52** TC7X Vehicle Communication Charging Cradle



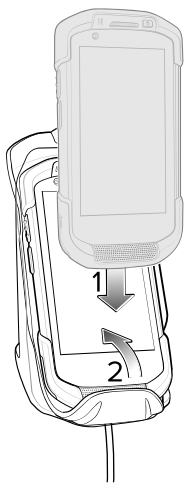
## Inserting the Device into the TC7X Vehicle Communication Charging Cradle

- To ensure the device was inserted correctly, listen for the audible click that signifies that the device locking mechanism was enabled and the device was locked into place.



**CAUTION:** Ensure that the device is fully inserted into the cradle. Lack of proper insertion may result in property damage or personal injury. Zebra Technologies Corporation is not responsible for any loss resulting from the use of the products while driving.

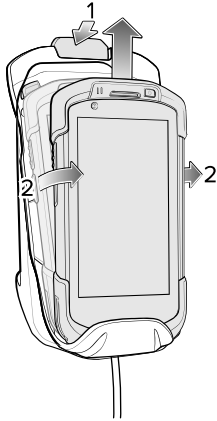
**Figure 53** Insert Device into Cradle



## Removing the Device from the TC7X Vehicle Communication Charging Cradle

- To remove the device from the cradle, press the release latch (1), grasp the device (2) and lift out of the vehicle cradle.

**Figure 54** Remove Device from Cradle



## Charging the Device in the TC7X Vehicle Communication Charging Cradle

- Insert the device into the cradle.

The device starts to charge through the cradle as soon as it is inserted. This does not deplete the vehicle battery significantly. The battery charges in approximately four hours. See [Charging Indicators](#) on page 31 for all charging indications.



**NOTE:** The Vehicle Cradle operating temperature is -40°C to +85°C. When in the cradle, the device will only charge when its temperature is between 0°C to +40°C.

## USB IO Hub

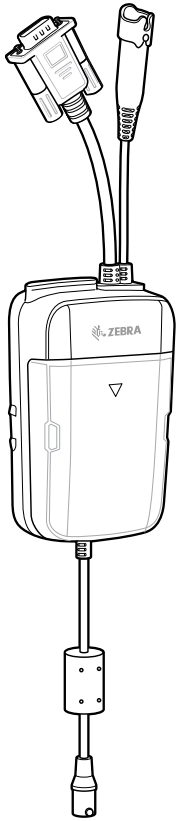
The USB I/O Hub:

- provides power to a vehicle cradle
- provides USB hub for three USB devices (such as printers)
- provides a powered USB port for charging another device.

The cradle is powered by the vehicle's 12V or 24V electrical system. The operating voltage range is 9V to 32V and supplies a maximum current of 3A to the vehicle cradle and 1.5 A to the four USB ports simultaneously.

Refer to the device Integrator Guide for Android 8.1 Oreo for information on installing the USB I/O Hub.

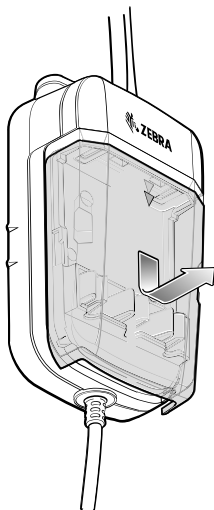
**Figure 55** USB I/O Hub



## Connecting Cables to the USB IO Hub

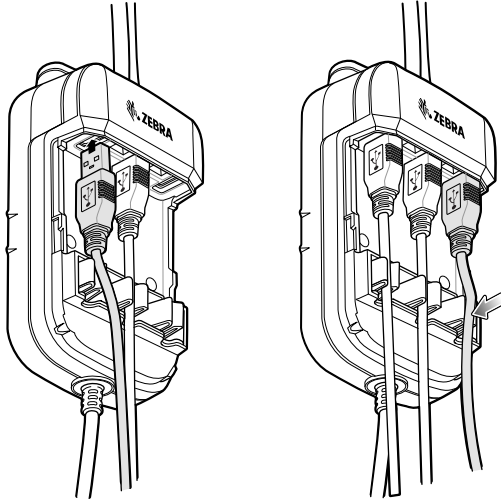
The USB I/O Hub provides three USB ports for connecting devices such as printers to a device in the vehicle cradle.

1. Slide the cable cover down and remove.

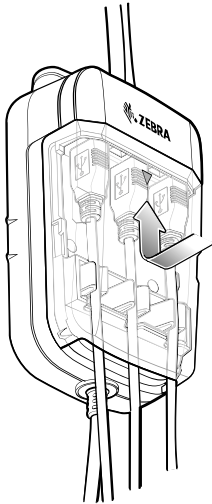


2. Insert the USB cable connector into one of the USB ports.

3. Place each cable into the cable holder.



4. Align the cable cover onto the USB I/O Hub. Ensure that the cables are within the cover opening.



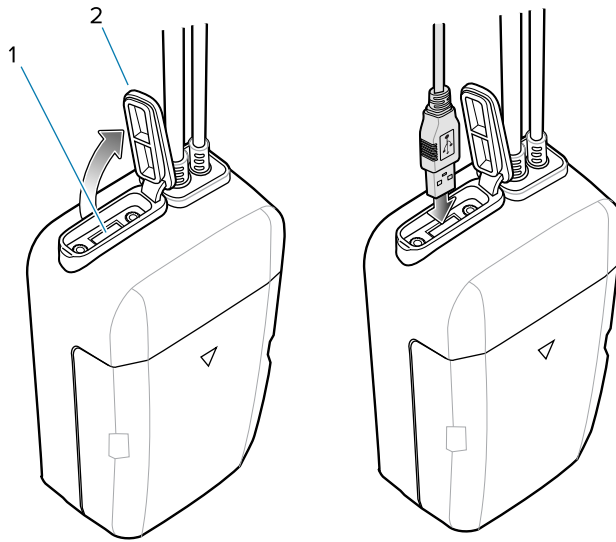
5. Slide cable cover up to lock into place.

## Connecting External Cable to the USB IO Hub

The USB I/O Hub provides a USB port for charging external devices such as cell phones. This port is for charging only.

1. Open the USB Access Cover.

2. Insert the USB cable connector into the USB port.



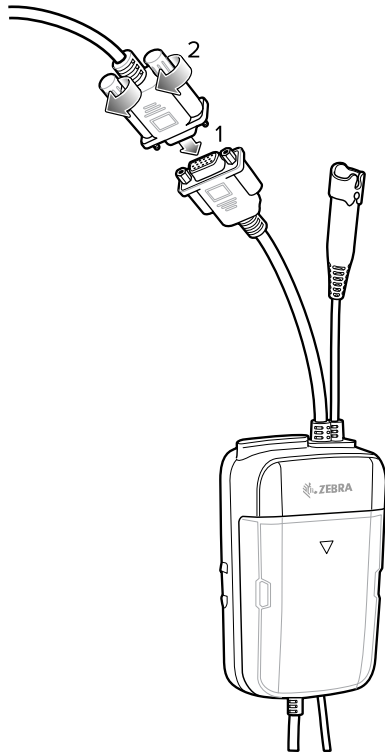
1	USB port
2	USB port access cover

## Powering the Vehicle Cradle

The USB I/O Hub can provide power to a Vehicle Cradle.

1. Connect the Power Output Cable connector to the Power Input Cable connector of the Vehicle Cradle.

2. Tighten thumbscrews by hand until tight.



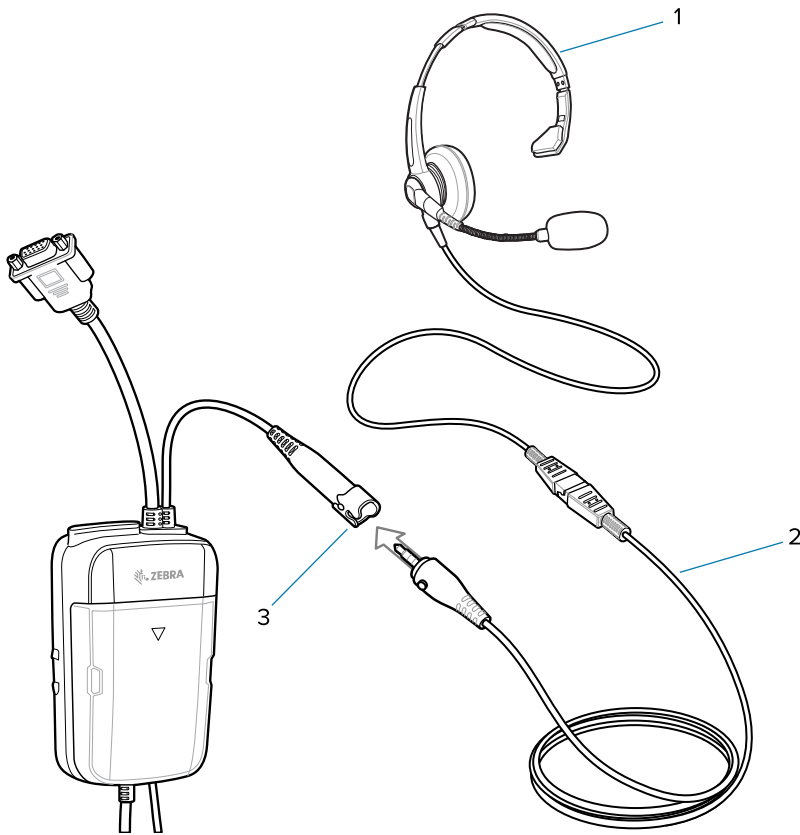
1	Vehicle cradle power and communication connector
2	Power and communication connector

## Audio Headset Connection

The USB I/O Hub provides audio connection to the device in a vehicle cradle.

Depending upon the headset, connect the headset and audio adapter to the Headset connector.

**Figure 56** Connect Audio Headset



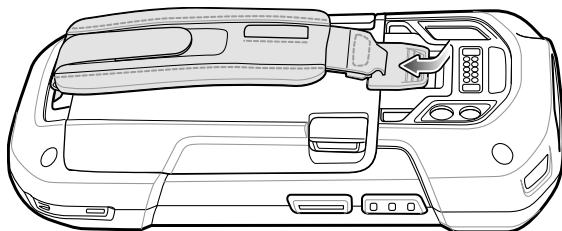
1	Headset
2	Adapter cable
3	Collar

## Replacing the Hand Strap



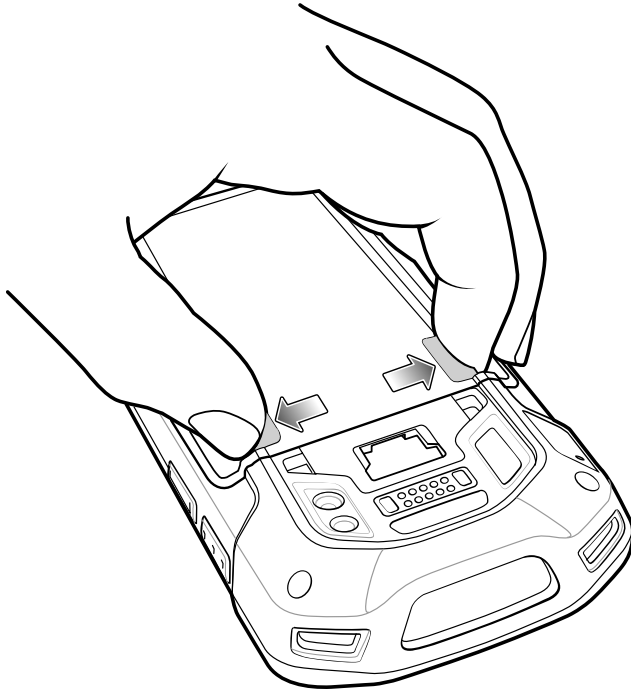
**CAUTION:** Close all running applications prior to replacing the hand strap.

1. Press and hold the **Power** button until the menu appears.
2. Touch **Power Off**.
3. Touch **OK**.
4. Remove the hand strap clip from the hand strap mounting slot.

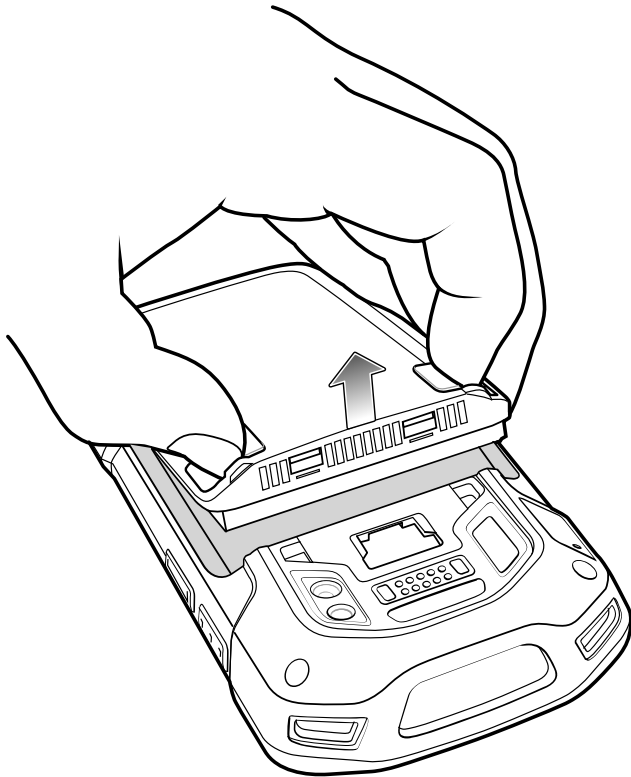




5. Press the two battery latches in.

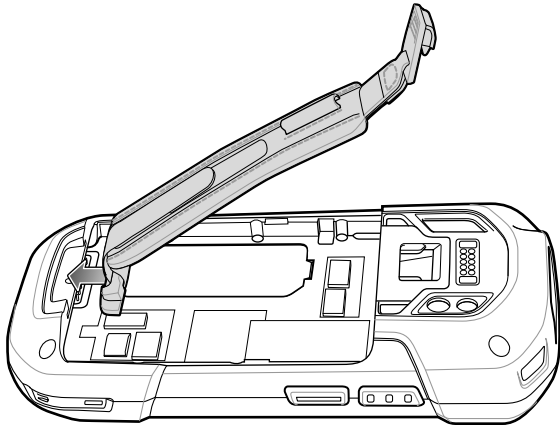


6. Lift the battery from the device.

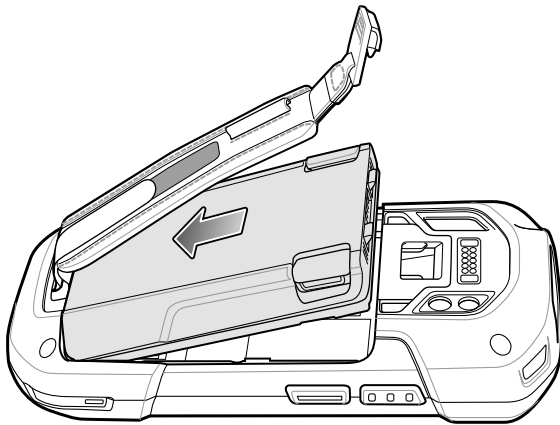


7. Remove the battery.
8. Remove the hand strap plate from the hand strap slot.

9. Insert the replacement hand strap plate into the hand strap slot.

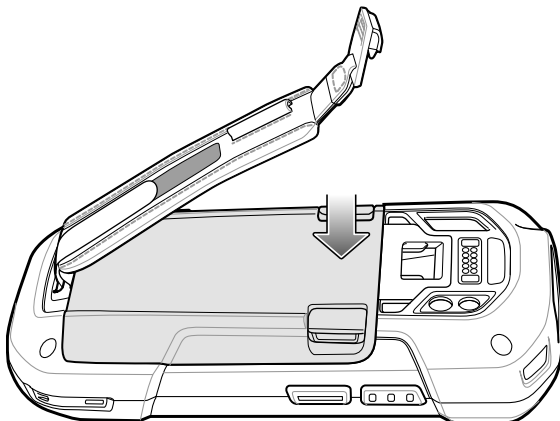


10. Insert the battery, bottom first, into the battery compartment.

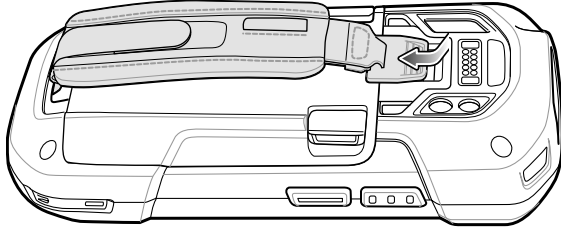


11. Rotate the top of the battery into the battery compartment.

12. Press the battery down into the battery compartment until the battery release latches snap into place.



13. Place hand strap clip into hand strap mounting slot and pull down until it snaps into place.



# Application Deployment

This section provides an overview of device security, app development, and app management. It also provides instructions for installing apps and updating the device software.



**NOTE:** Ensure the date is set correctly before installing certificates or when accessing secure websites.

## Android Security

The device implements a set of security policies that determine whether an application is allowed to run and, if allowed, with what level of trust. To develop an application, you must know the security configuration of the device, and how to sign an application with the appropriate certificate to allow the application to run (and to run with the needed level of trust).



**NOTE:** Ensure the date is set correctly before installing certificates or when accessing secure web sites.

## Secure Certificates

If the VPN or Wi-Fi networks rely on secure certificates, obtain the certificates and store them in the device's secure credential storage, before configuring access to the VPN or Wi-Fi networks.

If downloading the certificates from a web site, set a password for the credential storage. The device supports X.509 certificates saved in PKCS#12 key store files with a .p12 extension (if key store has a .pfx or other extension, change to .p12).

The device also installs any accompanying private key or certificate authority certificates contained in the key store.

## Installing a Secure Certificate

If required by the VPN or Wi-Fi network, install a secure certificate on the device.

1. Copy the certificate from the host computer to the root of the microSD card or the device's internal memory. See [Transferring Files](#) on page 49 for information about connecting the device to a host computer and copying files.
2. Go to **Settings**.
3. Touch **Security** > **Encryption & credentials**.
4. Touch **Install a certificate**.

5. Navigate to the location of the certificate file.
6. Touch the filename of the certificate to install.
7. If prompted, enter the password for credential storage. If a password has not been set for the credential storage, enter a password for it twice, and then touch **OK**.
8. If prompted, enter the certificate's password and touch **OK**.
9. Enter a name for the certificate and in the Credential use drop-down, select **VPN and apps** or **Wi-Fi**.
10. Touch **OK**.

The certificate can now be used when connecting to a secure network. For security, the certificate is deleted from the microSD card or internal memory.

### Configuring Credential Storage Settings

Configure credential storage from the device settings.

1. Go to **Settings**.
2. Touch **Security > Encryption & credentials**.
3. Select an option.
  - Touch **Trusted credentials** to display the trusted system and user credentials.
  - Touch **User credentials** to display user credentials.
  - Touch **Install from storage** to install a secure certificate from the microSD card or internal storage.
  - Touch **Clear credentials** to delete all secure certificates and related credentials.

## Android Development Tools

Development tools for Android include Android Studio, EMDK for Android, and StageNow.

### Android Development Workstation

Android development tools are available at [developer.android.com](http://developer.android.com).

To start developing applications for the device, download Android Studio. Development can take place on a Microsoft® Windows®, Mac® OS X®, or Linux® operating system.

Applications are written in Java or Kotlin, but compiled and executed in the Dalvik virtual machine. Once the Java code is compiled cleanly, the developer tools make sure the application is packaged properly, including the AndroidManifest.xml file.

Android Studio contains a full featured IDE as well as SDK components required to develop Android applications.

### Enabling Developer Options

The **Developer options** screen sets development-related settings. By default, the Developer Options are hidden.

1. Go to **Settings**.
2. Touch **About phone**.

3. Scroll down to **Build number**.
4. Tap **Build number** seven times.  
The message **You are now a developer!** appears.
5. Touch **Back**.
6. Touch **System > Advanced > Developer options**.
7. Slide the **USB debugging** switch to the **ON** position.

### EMDK for Android

EMDK for Android provides developers with tools to create business applications for enterprise mobile devices. It is designed for use with Google's Android Studio and includes Android class libraries such as Barcode, sample applications with source code, and the associated documentation.

EMDK for Android allows applications to take full advantage of the capabilities that Zebra devices have to offer. It embeds Profile Manager technology within Android Studio IDE, providing a GUI-based development tool designed specifically for Zebra devices. This allows fewer lines of code, resulting in reduced development time, effort, and errors.

#### See Also

[For more information go to techdocs.zebra.com.](#)

### StageNow for Android

StageNow is Zebra's next-generation Android Staging Solution built on the MX platform. It allows quick and easy creation of device profiles, and can deploy to devices simply by scanning a barcode, reading a tag, or playing an audio file.

The StageNow Staging Solution includes the following components:

- The StageNow Workstation tool installs on the staging workstation (host computer) and lets the administrator easily create staging profiles for configuring device components, and perform other staging actions such as checking the condition of a target device to determine suitability for software upgrades or other activities. The StageNow Workstation stores profiles and other created content for later use.
- The StageNow Client resides on the device and provides a user interface for the staging operator to initiate staging. The operator uses one or more of the desired staging methods (print and scan a barcode, read an NFC tag or play an audio file) to deliver staging material to the device.

#### See Also

[For more information go to techdocs.zebra.com.](#)

### GMS Restricted

GMS Restricted mode deactivates Google Mobile Services (GMS). All GMS apps are disabled on the device and communication with Google (analytics data collection and location services) is disabled.

Use StageNow to disable or enable GMS Restricted mode. After a device is in GMS Restricted mode, enable and disable individual GMS apps and services using StageNow. To ensure GMS Restricted mode persists after an Enterprise Reset, use the Persist Manager option in StageNow.

**See Also**

[For more information on StageNow, refer to techdocs.zebra.com.](https://techdocs.zebra.com)

## ADB USB Setup

To use the ADB, install the development SDK on the host computer then install the ADB and USB drivers.

Before installing the USB driver, make sure that the development SDK is installed on the host computer. Go to [developer.android.com/sdk/index.html](https://developer.android.com/sdk/index.html) for details on setting up the development SDK.

The ADB and USB drivers for Windows and Linux are available on the Zebra Support Central web site at [zebra.com/support](https://zebra.com/support). Download the ADB and USB Driver Setup package. Follow the instructions with the package to install the ADB and USB drivers for Windows and Linux.

## Enabling USB Debugging

By default, USB debugging is disabled.

1. Go to **Settings**.
2. Touch **About phone**.
3. Scroll down to **Build number**.
4. Tap **Build number** seven times.  
The message **You are now a developer!** appears.
5. Touch **Back**.
6. Touch **System > Advanced > Developer options**.
7. Slide the **USB debugging** switch to the **ON** position.
8. Touch **OK**.
9. Connect the device to the host computer using the Rugged Charge/USB Cable.

The **Allow USB debugging?** dialog box appears on the device.

If the device and host computer are connected for the first time, the **Allow USB debugging?** dialog box with the **Always allow from this computer** check box displays. Select the check box, if required.

10. Touch **OK**.
11. On the host computer, navigate to the **platform-tools** folder and open a command prompt window.
12. Type `adb devices`.

The following displays:

```
List of devices attached          XXXXXXXXXXXXXXXXXXXX device
```

Where XXXXXXXXXXXXXXXXXXXX is the device number.



**NOTE:** If device number does not appear, ensure that ADB drivers are installed properly.

## Entering Android Recovery Manually

Many of the update methods discussed in this section require putting the device into Android Recovery mode. If you are unable to enter Android Recovery mode through adb commands, use the following steps to manually enter Android Recovery mode.

1. Press and hold the Power button until the menu appears.
2. Touch **Restart**.
3. Press and hold the PTT button until the device vibrates  
The System Recovery screen appears.

## Application Installation Methods

After an application is developed, install the application onto the device using one of the supported methods.

- USB connection
- Android Debug Bridge
- microSD Card
- Mobile device management (MDM) platforms that have application provisioning. Refer to the MDM software documentation for details.

## Installing Applications Using the USB Connection

Use the USB connection to install applications onto the device.




**CAUTION:** When connecting the device to a host computer and mounting the microSD card, follow the host computer's instructions for connecting and disconnecting USB devices, to avoid damaging or corrupting files.

1. Connect the device to a host computer using USB.
2. On the device, pull down the Notification panel and touch **Charging this device via USB**.  
By default, **No data transfer** is selected.
3. Touch **File Transfer**.
4. On the host computer, open a file explorer application.
5. On the host computer, copy the application APK file from the host computer to the device.



**CAUTION:** Carefully follow the host computer's instructions to unmount the microSD card and disconnect USB devices correctly to avoid losing information.

6. Disconnect the device from the host computer.
7. Swipe the screen up and select  to view files on the microSD card or Internal Storage.
8. Locate the application APK file.
9. Touch the application file.
10. Touch **Continue** to install the app or **Cancel** to stop the installation.
11. To confirm installation and accept what the application affects, touch **Install** otherwise touch **Cancel**.



12. Touch **Open** to open the application or **Done** to exit the installation process.

The application appears in the App list.

### Installing Applications Using the Android Debug Bridge

Use ADB commands to install applications onto the device.



**CAUTION:** When connecting the device to a host computer and mounting the microSD card, follow the host computer's instructions for connecting and disconnecting USB devices to avoid damaging or corrupting files.

1. Ensure that the ADB drivers are installed on the host computer.
2. Connect the device to a host computer using a USB-C cable or by inserting the device into the 1-Slot USB/Ethernet Cradle.
3. Go to **Settings**.
4. Touch **System > Advanced > Developer options**.
5. Slide the **USB debugging** switch to the **ON** position.
6. Touch **OK**.
7. If the device and host computer are connected for the first time, the **Allow USB debugging?** dialog box with the **Always allow from this computer** check box displays. Select the check box, if required.
8. Touch **OK** or **Allow**.
9. On the host computer, navigate to the **platform-tools** folder and open a command prompt window.
10. Type `adb install <application>`.  
where: <application> = the path and filename of the apk file.
11. Disconnect the device from the host computer.

### Installing Applications Using Wireless ADB

Use ADB commands to install an application onto the device.

Go to the Zebra Support & Downloads web site at [zebra.com/support](https://zebra.com/support) and download the appropriate Factory Reset file to a host computer.



**IMPORTANT:** Ensure the latest adb files are installed on the host computer.

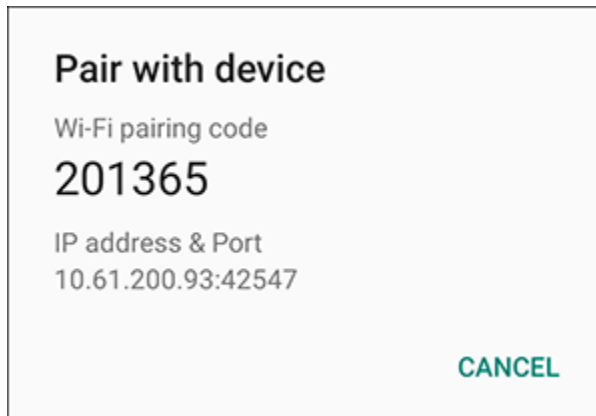


**IMPORTANT:** The device and host computer must be on the same wireless network.

1. Go to **Settings**.
2. Touch **System > Advanced > Developer options**.
3. Slide the **USB debugging** switch to the **ON** position.
4. Slide the **Wireless debugging** switch to the **ON** position.
5. If the device and host computer are connected for the first time, the **Allow wireless debugging on this network?** dialog box with the **Always allow from this network** check box displays. Select the check box, if required.
6. Touch **ALLOW**.

7. Touch **Wireless debugging**.
8. Touch **Pair with pairing code**.

The **Pair with device** dialog box displays.



9. On the host computer, navigate to the **platform-tools** folder and open a command prompt window.
10. Type `adb pair XX.XX.XX.XX.XXXXXX`.  
where `XX.XX.XX.XX.XXXXXX` is the IP address and port number from the **Pair with device** dialog box.
11. Type: `adb connect XX.XX.XX.XX.XXXXXX`
12. Press **Enter**.
13. Type the pairing code from the **Pair with device** dialog box.
14. Press **Enter**.
15. Type `adb connect`.  
The device is now connected to the host computer.
16. Type `adb devices`.  
The following displays:

```
List of devices attached      XXXXXXXXXXXXXXXXXXXX device
```

Where `XXXXXXXXXXXXXXXXXX` is the device number.



**NOTE:** If device number does not appear, ensure that ADB drivers are installed properly.

17. On the host computer command prompt window type:

```
adb install <application>
```

where: `<file>` = the path and filename of the apk file.



18. On the host computer, type:  
`adb disconnect`.

## Installing Applications Using a microSD Card

Use a microSD card to install applications on your device.



**CAUTION:** When connecting the device to a host computer and mounting the microSD card, follow the host computer's instructions for connecting and disconnecting USB devices, to avoid damaging or corrupting files.

1. Copy the APK file to the root of the microSD card.
  - Copy the APK file to a microSD card using a host computer (see [Transferring Files](#) for more information), and then install the microSD card into the device (see [Replacing the microSD Card](#) on page 35 for more information).
  - Connect the device with a microSD card already installed to the host computer, and copy the .apk file to the microSD card. See [Transferring Files](#) for more information. Disconnect the device from the host computer.
2. Swipe the screen up and select  to view files on the microSD card.
3. Touch  **SD card**.
4. Locate the application APK file.
5. Touch the application file.
6. Touch **Continue** to install the app or **Cancel** to stop the installation.
7. To confirm installation and accept what the application affects, touch **Install** otherwise touch **Cancel**.
8. Touch **Open** to open the application or **Done** to exit the installation process.

The application appears in the App list.

## Uninstalling an Application

Free up device memory by removing unused apps.

1. Go to **Settings**.
2. Touch **Apps & notifications**.
3. Touch **See all apps** to view all apps in the list.
4. Scroll through the list to the app.
5. Touch the app. The **App info** screen appears.
6. Touch **Uninstall**.
7. Touch **OK** to confirm.

## Android System Update

System Update packages can contain either partial or complete updates for the operating system. Zebra distributes the System Update packages on the Zebra Support & Downloads website. Perform a system update using either a microSD card or using ADB.

### Performing a System Update Using microSD Card

Go to the Zebra Support & Downloads web site at [zebra.com/support](http://zebra.com/support) and download the appropriate System Update package to a host computer.

1. Copy the APK file to the root of the microSD card.
  - Copy the APK file to a microSD card using a host computer (see [Transferring Files](#) for more information), and then install the microSD card into the device (see [Replacing the microSD Card](#) on page 35 for more information).
  - Connect the device with a microSD card already installed to the host computer, and copy the .apk file to the microSD card. See [Transferring Files](#) for more information. Disconnect the device from the host computer.
2. Press and hold **Power** until the menu appears.
3. Touch **Restart**.
4. Press and hold **PTT** until the device vibrates.  
The System Recovery screen appears.
5. Press **Up** and **Down** to navigate to **Apply upgrade from SD card**.
6. Press **Power**.
7. Press **Volume Up** and **Volume Down** to navigate to the System Update file.
8. Press **Power**. The System Update installs and then the device returns to the Recovery screen.
9. Press **Power** to reboot the device.

### Performing a System Update Using ADB

Go to the Zebra Support & Downloads web site at [zebra.com/support](http://zebra.com/support) and download the appropriate System Update package to a host computer.

1. Connect the device to a host computer using USB.
2. Go to **Settings**.
3. Touch **System > Advanced > Developer options**.
4. Slide the **USB debugging** switch to the **ON** position.
5. Touch **OK**.
6. If the device and host computer are connected for the first time, the **Allow USB debugging?** dialog box with the **Always allow from this computer** check box displays. Select the check box, if required.
7. Touch **OK** or **Allow**.
8. On the host computer, navigate to the **platform-tools** folder and open a command prompt window.

9. Type `adb devices`.

The following displays:

```
List of devices attached          XXXXXXXXXXXXXXXXXXXX device
```

Where XXXXXXXXXXXXXXXXXXXX is the device number.



**NOTE:** If device number does not appear, ensure that ADB drivers are installed properly.

10. Type:

```
adb reboot recovery
```

11. Press **Enter**.

The System Recovery screen appears on the device.

12. Press **Volume Up** and **Volume Down** to navigate to **Apply upgrade from ADB**.

13. Press **Power**.

14. On the host computer command prompt window type:

```
adb sideload <file>
```

where: <file> = the path and filename of the zip file.

15. Press **Enter**.

The System Update installs (progress appears as percentage in the Command Prompt window) and then the System Recovery screen appears on the device.

16. Press **Power** to reboot the device.

If you are not able to enter Android Recovery mode through the adb command, see [Entering Android Recovery Manually](#) on page 216.

## Performing a System Update Using Wireless ADB

Use wireless ADB to perform a system update.

Go to the Zebra Support & Downloads web site at [zebra.com/support](http://zebra.com/support) and download the appropriate System Update package to a host computer.



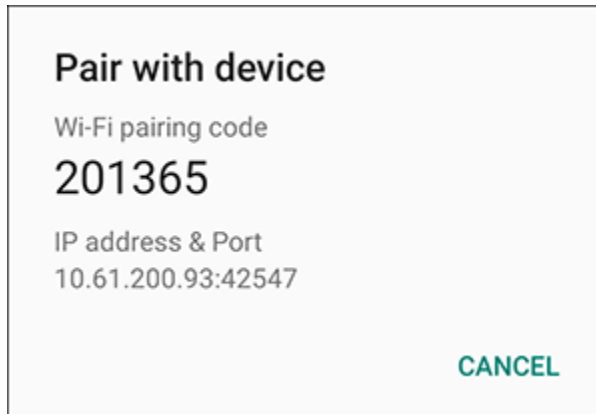
**IMPORTANT:** Ensure the latest adb files are installed on the host computer.

The device and the host computer must be on the same wireless network.

1. Go to **Settings**.
2. Touch **System > Advanced > Developer options**.
3. Slide the **USB debugging** switch to the **ON** position.
4. Slide the **Wireless debugging** switch to the **ON** position.
5. Touch **Wireless debugging**.

6. If the device and host computer are connected for the first time, the **Allow wireless debugging on this network?** dialog box with the **Always allow from this network** check box displays. Select the check box, if required.
7. Touch **ALLOW**.
8. Touch **Pair with pairing code**.

The **Pair with device** dialog box displays.



9. On the host computer, navigate to the **platform-tools** folder and open a command prompt window.
10. Type `adb pair XX.XX.XX.XX.XXXXXX`,  
where `XX.XX.XX.XX.XXXXXX` is the IP address and port number from the **Pair with device** dialog box.
11. Press **Enter**.
12. Type the pairing code from the **Pair with device** dialog box.
13. Press **Enter**.
14. Type `adb connect`.  
The device is now connected to the host computer.
15. Type:  
`adb reboot recovery`
16. Press **Enter**.  
The System Recovery screen appears on the device.
17. Press **Volume Up** and **Volume Down** to navigate to **Apply upgrade from ADB**.
18. Press **Power**.
19. On the host computer command prompt window type:

```
adb sideload <file>
```

where: `<file>` = the path and filename of the zip file.

20. Press **Enter**.  
The System Update installs (progress appears as percentage in the Command Prompt window) and then the System Recovery screen appears on the device.
21. Navigate to **Reboot system now** and press the Power button to reboot the device.

22. On the host computer, type:

```
adb disconnect.
```

If you are not able to enter Android Recovery mode through the adb command, see [Entering Android Recovery Manually](#) on page 216.

### Verifying System Update Installation

Verify that the system update was successful.

1. Go to **Settings**.
2. Touch **About phone**.
3. Scroll down to **Build number**.
4. Ensure that the build number matches the new system update package file number.

### Android Enterprise Reset

An Enterprise Reset erases all user data in the /data partition, including data in the primary storage locations (emulated storage). Zebra distributes the Enterprise Reset packages on the Zebra Support & Downloads website. An Enterprise Reset erases all user data in the /data partition, including data in the primary storage locations (/sdcard and emulated storage). Zebra distributes the Enterprise Reset packages on the Zebra Support & Downloads website.

Before performing an Enterprise Reset, provision all necessary configuration files and restore after the reset.

### Performing an Enterprise Reset From Device Settings

Perform an Enterprise Reset from the device settings.

1. Go to **Settings**.
2. Touch **System > Advanced > Reset Options > Erase all data (enterprise reset)**.
3. Touch **Erase all data** twice to confirm the Enterprise Reset.

### Performing an Enterprise Reset Using microSD Card

Go to the Zebra Support & Downloads web site at [zebra.com/support](http://zebra.com/support) and download the appropriate Enterprise Reset file to a host computer.

1. Copy the APK file to the root of the microSD card.
  - Copy the APK file to a microSD card using a host computer (see [Transferring Files](#) for more information), and then install the microSD card into the device (see [Replacing the microSD Card](#) on page 35 for more information).
  - Connect the device with a microSD card already installed to the host computer, and copy the .apk file to the microSD card. See [Transferring Files](#) for more information. Disconnect the device from the host computer.
2. Press and hold **Power** until the menu appears.
3. Touch **Restart**.

4. Press and hold **PTT** until the device vibrates.  
The System Recovery screen appears.
5. Press **Volume Up** and **Volume Down** to navigate to **Apply upgrade from SD card**.
6. Press **Power**.
7. Press **Volume Up** and **Volume Down** to navigate to the Enterprise Reset file.
8. Press **Power**.  
The Enterprise Reset occurs and then the device returns to the Recovery screen.
9. Press **Power** to reboot the device.

### Performing an Enterprise Reset Using Wireless ADB

Perform an Enterprise Reset using Wireless ADB.

Go to the Zebra Support & Downloads web site at [zebra.com/support](http://zebra.com/support) and download the appropriate Factory Reset file to a host computer.



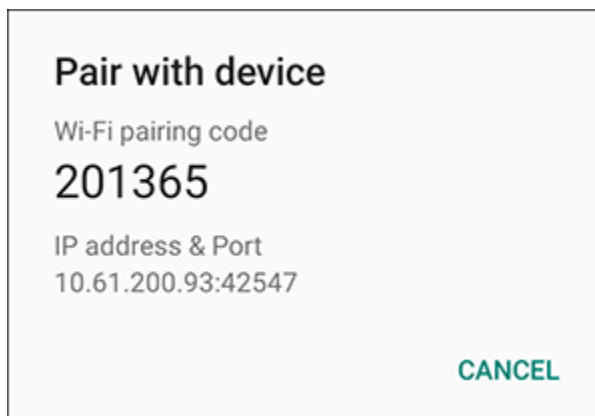
**IMPORTANT:** Ensure the latest adb files are installed on the host computer.



**IMPORTANT:** The device and host computer must be on the same wireless network.

1. Go to **Settings**.
2. Touch **System > Advanced > Developer options**.
3. Slide the **USB debugging** switch to the **ON** position.
4. Slide the **Wireless debugging** switch to the **ON** position.
5. If the device and host computer are connected for the first time, the **Allow wireless debugging on this network?** dialog box with the **Always allow from this network** check box displays. Select the check box, if required.
6. Touch **ALLOW**.
7. Touch **Wireless debugging**.
8. Touch **Pair with pairing code**.

The **Pair with device dialog** box displays.





9. On the host computer, navigate to the **platform-tools** folder and open a command prompt window.
10. Type `adb pair XX.XX.XX.XX.XXXXX`.  
where `XX.XX.XX.XX.XXXXX` is the IP address and port number from the **Pair with device** dialog box.
11. Type: `adb connect XX.XX.XX.XX.XXXXX`
12. Press **Enter**.
13. Type the pairing code from the **Pair with device** dialog box
14. Press **Enter**.
15. Type `adb connect`.  
The device is now connected to the host computer.
16. Type `adb devices`.  
The following displays:

```
List of devices attached      XXXXXXXXXXXXXXXXXXXX device
```

Where XXXXXXXXXXXXXXXXXXXX is the device number.



**NOTE:** If device number does not appear, ensure that ADB drivers are installed properly.

17. Type:  
`adb reboot recovery`
18. Press **Enter**.  
The Factory Recovery screen appears on the device.
19. Press **Volume Up** and **Volume Down** to navigate to **Apply upgrade from ADB**.
20. Press **Power**.
21. On the host computer command prompt window type:

```
adb sideload <file>
```

where: `<file>` = the path and filename of the zip file.

22. Press **Enter**.  
The Enterprise Reset package installs and then the System Recovery screen appears on the device.
23. Press **Power** to reboot the device.
24. On the host computer, type:  
`adb disconnect`.

If you are not able to enter Android Recovery mode through the adb command, see [Entering Android Recovery Manually](#) on page 216.

### Performing an Enterprise Reset Using ADB

Go to the Zebra Support & Downloads web site at [zebra.com/support](http://zebra.com/support) and download the appropriate Enterprise Reset file to a host computer.

1. Connect the device to a host computer using a USB-C cable or by inserting the device into the 1-Slot USB/Ethernet Cradle.
2. Go to **Settings**.
3. Touch **System** > **Advanced** > **Developer options** .
4. Slide the **USB debugging** switch to the **ON** position.
5. Touch **OK**.
6. If the device and host computer are connected for the first time, the **Allow USB debugging?** dialog box with the **Always allow from this computer** check box displays. Select the check box, if required.
7. Touch **OK** or **Allow**.
8. On the host computer, navigate to the **platform-tools** folder and open a command prompt window.
9. Type `adb devices`.

The following displays:

```
List of devices attached          XXXXXXXXXXXXXXXXX device
```

Where XXXXXXXXXXXXXXXXX is the device number.



**NOTE:** If device number does not appear, ensure that ADB drivers are installed properly.

10. Type:
 

```
adb reboot recovery
```
11. Press **Enter**.
 

The System Recovery screen appears on the device.
12. Press **Volume Up** and **Volume Down** to navigate to **Apply upgrade from ADB**.
13. Press **Power**.
14. On the host computer command prompt window type:

```
adb sideload <file>
```

where: <file> = the path and filename of the zip file.

15. Press **Enter**.
 

The Enterprise Reset package installs and then the System Recovery screen appears on the device.
16. Press **Power** to reboot the device.

If you are not able to enter Android Recovery mode through the adb command, see [Entering Android Recovery Manually](#) on page 216.

## Android Factory Reset

A Factory Reset erases all data in the /data and /enterprise partitions in internal storage and clears all device settings. A Factory Reset returns the device to the last installed operating system image. To revert to a previous operating system version, re-install that operating system image. Zebra distributes the Factory Reset packages on the Zebra Support & Downloads website.

## Performing a Factory Reset Using microSD Card

Go to the Zebra Support & Downloads web site at [zebra.com/support](https://zebra.com/support) and download the appropriate Factory Reset file to a host computer.

1. Copy the APK file to the root of the microSD card.
  - Copy the APK file to a microSD card using a host computer (see [Transferring Files](#) for more information), and then install the microSD card into the device (see [Replacing the microSD Card](#) on page 35 for more information).
  - Connect the device with a microSD card already installed to the host computer, and copy the .apk file to the microSD card. See [Transferring Files](#) for more information. Disconnect the device from the host computer.
2. Press and hold **Power** until the menu appears.
3. Touch **Restart**.
4. Press and hold **PTT** until the device vibrates.

The System Recovery screen appears.
5. Press **Volume Up** and **Volume Down** to navigate to **Apply upgrade from SD card**.
6. Press **Power**.
7. Press **Volume Up** and **Down Arrow** to navigate to the Factory Reset file.
8. Press **Power**.

The Factory Reset occurs and then the device returns to the Recovery screen.
9. Press **Power** to reboot the device.

## Performing a Factory Reset Using ADB

Go to the Zebra Support & Downloads web site at [zebra.com/support](https://zebra.com/support) and download the appropriate Factory Reset file to a host computer.

1. Connect the device to a host computer using a USB-C cable or by inserting the device into the 1-Slot USB/Ethernet Cradle.
2. Go to **Settings**.
3. Touch **System > Advanced > Developer options**.
4. Slide the **USB debugging** switch to the **ON** position.
5. Touch **OK**.
6. If the device and host computer are connected for the first time, the **Allow USB debugging?** dialog box with the **Always allow from this computer** check box displays. Select the check box, if required.
7. Touch **OK** or **ALLOW**.
8. On the host computer, navigate to the **platform-tools** folder and open a command prompt window.

- Type `adb devices`.

The following displays:

```
List of devices attached          XXXXXXXXXXXXXXXXXXXX device
```

Where XXXXXXXXXXXXXXXXXXXX is the device number.



**NOTE:** If device number does not appear, ensure that ADB drivers are installed properly.

- Type:

```
adb reboot recovery
```

- Press **Enter**.

The System Recovery screen appears on the device.

- Press **Volume Up** and **Volume Down** buttons to navigate to **Apply upgrade from ADB**.

- Press **Power**.

- On the host computer command prompt window type:

```
adb sideload <file>
```

where: <file> = the path and filename of the zip file.

- Press **Enter**.

The Factory Reset package installs and then the System Recovery screen appears on the device.

- Press **Power** to reboot the device.

If you are not able to enter Android Recovery mode through the adb command, see [Entering Android Recovery Manually](#) on page 216.

## Performing a Factory Rest Using Wireless ADB

Perform a Factory Reset using Wireless ADB.

Go to the Zebra Support & Downloads web site at [zebra.com/support](http://zebra.com/support) and download the appropriate Factory Reset file to a host computer.



**IMPORTANT:** Ensure the latest adb files are installed on the host computer.

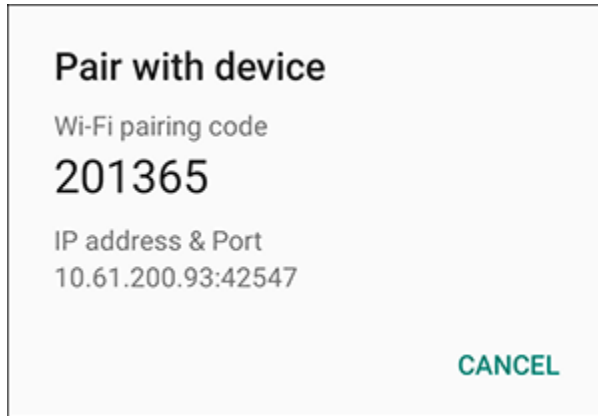


**IMPORTANT:** The device and host computer must be on the same wireless network.

- Go to **Settings**.
- Touch **System** > **Advanced** > **Developer options**.
- Slide the **USB debugging** switch to the **ON** position.
- Slide the **Wireless debugging** switch to the **ON** position.
- If the device and host computer are connected for the first time, the **Allow wireless debugging on this network?** dialog box with the **Always allow from this network** check box displays. Select the check box, if required.

6. Touch **ALLOW**.
7. Touch **Wireless debugging**.
8. Touch **Pair with pairing code**.

The **Pair with device** dialog box displays.



9. On the host computer, navigate to the **platform-tools** folder and open a command prompt window.
10. Type `adb pair XX.XX.XX.XX.XXXXXX`,  
where `XX.XX.XX.XX.XXXXXX` is the IP address and port number from the **Pair with device** dialog box.
11. Type: `adb connect XX.XX.XX.XX.XXXXXX`
12. Press **Enter**.
13. Type the pairing code from the **Pair with device** dialog box
14. Press **Enter**.
15. Type `adb connect`.  
The device is now connected to the host computer.
16. Type `adb devices`.  
The following displays:

```
List of devices attached      XXXXXXXXXXXXXXXXXXXX device
```

Where XXXXXXXXXXXXXXXXXXXX is the device number.



**NOTE:** If device number does not appear, ensure that ADB drivers are installed properly.

17. Type:  
`adb reboot recovery`
18. Press **Enter**.  
The Factory Reset package installs and then the System Recovery screen appears on the device.
19. Press **Volume Up** and **Volume Down** to navigate to **Apply upgrade from ADB**.
20. Press **Power**.

21. On the host computer command prompt window type:

```
adb sideload <file>
```

where: <file> = the path and filename of the zip file.

22. Press **Enter**.

The Factory Reset package installs and then the System Recovery screen appears on the device.

23. Press **Power** to reboot the device.

24. On the host computer, type:

```
adb disconnect.
```

If you are not able to enter Android Recovery mode through the adb command, see [Entering Android Recovery Manually](#) on page 216.

## Android Storage

The device contains multiple types of file storage.

- Random Access Memory (RAM)
- Internal storage
- External storage (microSD card)
- Enterprise folder.

## Random Access Memory

Executing programs use RAM to store data. Data stored in RAM is lost upon a reset.

The operating system manages how applications use RAM. It only allows applications and component processes and services to use RAM when required. It may cache recently used processes in RAM, so they restart more quickly when opened again, but it will erase the cache if it needs the RAM for new activities.

The screen displays the amount of used and free RAM.

- **Performance** - Indicates memory performance.
- **Total memory** - Indicates the total amount of RAM available.
- **Average used (%)** - Indicates the average amount of memory (as a percentage) used during the period of time selected (default - 3 hours).
- **Free** - Indicates the total amount of unused RAM.
- **Memory used by apps** - Touch to view RAM usage by individual apps.

## Viewing Memory

View the amount of memory used and free RAM.

1. Go to **Settings**.
2. Touch **System > Advanced > Developer options**.
3. Touch **Memory**.

## Internal Storage

The device has internal storage. The internal storage content can be viewed and files copied to and from when the device is connected to a host computer. Some applications are designed to be stored on the internal storage rather than in internal memory.

### Viewing Internal Storage

View available and used internal storage on the device.

1. Go to **Settings**.
2. Touch **Storage**.

**Internal Storage** displays the total amount of space on internal storage and amount used.


If the device has removable storage installed, touch **Internal shared storage** to display the amount of internal storage used by apps, photos, videos, audio, and other files.

## External Storage

The device can have a removable microSD card. The microSD card content can be viewed and files copied to and from when the device is connected to a host computer.


### Viewing External Storage

Portable storage displays the total amount of space on the installed microSD card and the amount used.

1. Go to **Settings**.
2. Touch **Storage**.  
Touch **SD card** to view the contents of the card.
3. To unmount the microSD card, touch .

### Formatting a microSD Card as Portable Storage

Format a microSD card as portable storage for the device.

1. Touch **SD card**.
2. Touch  > **Storage settings**.
3. Touch **Format**.
4. Touch **ERASE & FORMAT**.
5. Touch **DONE**.

### Formatting a microSD Card as Internal Memory

You can format a microSD card as internal memory to increase the actual amount of the device's internal memory. Once formatted, the microSD card can only be read by this device.



**NOTE:** The suggested maximum SD card size is 128 GB when using internal storage.

1. Touch **SD card**.

2. Touch **⋮** > **Storage settings**.
3. Touch **Format as internal**.
4. Touch **ERASE & FORMAT**.
5. Touch **DONE**.

### Enterprise Folder

The Enterprise folder (within internal flash) is a super-persistent storage that is persistent after a reset and an Enterprise Reset.

The Enterprise folder is erased during a Factory Reset. The Enterprise folder is used for deployment and device-unique data. The Enterprise folder is approximately 128 MB (formatted). Applications can persist data after an Enterprise Reset by saving data to the enterprise/user folder. The folder is ext4 formatted and is only accessible from a host computer using ADB or from an MDM.

### Managing Apps

Apps use two kinds of memory: storage memory and RAM. Apps use storage memory for themselves and any files, settings, and other data they use. They also use RAM when they are running.

1. Go to **Settings**.
2. Touch **Apps & notifications**.
3. Touch **See all XX apps** to view all apps on the device.
4. Touch **⋮** > **Show system** to include system processes in the list.
5. Touch an app, process, or service in the list to open a screen with details about it and, depending on the item, to change its settings, permissions, notifications and to force stop or uninstall it.

### App Details

Apps have different kinds of information and controls.




- **Force stop** - Stop an app.
- **Disable** - Disable an app.
- **Uninstall** - Remove the app and all of its data and settings from the device.
- **Notifications** - Set the app notification settings.
- **Permissions** - Lists the areas on the device that the app has access to.
- **Storage & cache** - Lists how much information is stored and includes buttons for clearing it.
- **Mobile data & Wi-Fi** - Provides information about data consumed by an app.



- **Advanced**
  - **Screen time** - Displays the amount of time the app has displayed on the screen.
  - **Battery** - Lists the amount of computing power used by the app.
  - **Open by default** - If you have configured an app to launch certain file types by default, you can clear that setting here.
  - **Display over other apps** - Allows an app to display on top of other apps.
  - **App details** - Provides a link to additional app details on the Play store.
  - **Additional settings in the app** - Opens settings in the app.
  - **Modify system settings** - Allows an app to modify the system settings.

## Managing Downloads

Files and apps downloaded using the Browser or Email are stored on the microSD card or Internal storage in the Download directory. Use the Downloads app to view, open, or delete downloaded items.

1. Swipe the screen up and touch .
2. Touch  > **Downloads**.
3. Touch and hold an item, select items to delete and touch . The item is deleted from the device.

# Maintenance and Troubleshooting

Maintenance and troubleshooting information for the device and charging accessories.

## Maintaining the Device

Follow these guidelines to maintain the device properly.

For trouble-free service, observe the following tips when using the device:

- To avoid scratching the screen, use a Zebra approved capacitive compatible stylus intended for use with a touch-sensitive screen. Never use an actual pen or pencil or other sharp object on the surface of the device screen.
- The touch-sensitive screen of the device is glass. Do not drop the device or subject it to strong impact.
- Protect the device from temperature extremes. Do not leave it on the dashboard of a car on a hot day, and keep it away from heat sources.
- Do not store the device in any location that is dusty, damp, or wet.
- Use a soft lens cloth to clean the device. If the surface of the device screen becomes soiled, clean it with a soft cloth moistened with an approved cleanser.
- Periodically replace the rechargeable battery to ensure maximum battery life and product performance. Battery life depends on individual usage patterns.

## Battery Safety Guidelines

- The area in which the units are charged should be clear of debris and combustible materials or chemicals. Particular care should be taken where the device is charged in a non-commercial environment.
- Follow battery usage, storage, and charging guidelines found in this guide.
- Improper battery use may result in a fire, explosion, or other hazard.
- To charge the mobile device battery, the ambient battery and charger temperatures must be between 0°C to 40°C (32°F to 104°F).
- Do not use incompatible batteries and chargers, including non-Zebra batteries and chargers. Use of an incompatible battery or charger may present a risk of fire, explosion, leakage, or other hazard. If you have any questions about the compatibility of a battery or a charger, contact the Global Customer Support Center.

- For devices that utilize a USB port as a charging source, the device shall only be connected to products that bear the USB-IF logo or have completed the USB-IF compliance program.
- Do not disassemble or open, crush, bend or deform, puncture, or shred the battery.
- Severe impact from dropping any battery-operated device on a hard surface could cause the battery to overheat.
- Do not short circuit a battery or allow metallic or conductive objects to contact the battery terminals.
- Do not modify or remanufacture, attempt to insert foreign objects into the battery, immerse or expose to water or other liquids, or expose to fire, explosion, or other hazard.
- Do not leave or store the equipment in or near areas that might get very hot, such as in a parked vehicle or near a radiator or other heat source. Do not place battery into a microwave oven or dryer.
- Battery usage by children should be supervised.
- Please follow local regulations to properly dispose of used rechargeable batteries.
- Do not dispose of batteries in fire.
- In the event of a battery leak, do not allow the liquid to come in contact with the skin or eyes. If contact has been made, wash the affected area with water for 15 minutes, and seek medical advice.
- If you suspect damage to your equipment or battery, contact Customer Support to arrange for inspection.

## Best Practices for Enterprise Mobile Computing Devices Operating in Hot Environments and Direct Sunlight

Exceeding the operating temperature by external hot environments will cause the device's thermal sensor to notify the user of a shutdown of the WAN modem or shutdown the device until the device's temperature returns to the operational temperature range.

- Avoid direct sunlight to the device - The easiest way to prevent overheating is to keep the device out of direct sunlight. The device absorbs light and heat from the sun and retains it, getting hotter the longer it remains in sunlight and heat.
- Avoid leaving the device in a vehicle on a hot day or hot surface - Similar to leaving the device out in direct sunlight, the device will also absorb the thermal energy from a hot surface or when left on the dashboard of a vehicle or seat, getting warmer the longer it remains on the hot surface or inside the hot vehicle.
- Turn off unused apps on the device. Open, unused apps running in the background can cause the device to work harder, which in turn may cause it to heat up. This will also improve your mobile computer device's battery life performance.
- Avoid turning your screen brightness up - Just the same as running background apps, turning your brightness up will force your battery to work harder and create more heat. Minimizing your screen brightness may extend operating the mobile computer device in hot environments.

## Cleaning Instructions



**CAUTION:** Always wear eye protection. Read the warning label on alcohol product before using. If you have to use any other solution for medical reasons please contact the Global Customer Support Center for more information.



**WARNING:** Avoid exposing this product to contact with hot oil or other flammable liquids. If such exposure occurs, unplug the device and clean the product immediately in accordance with these guidelines.

### Approved Cleanser Active Ingredients

100% of the active ingredients in any cleaner must consist of one or some combination of the following: isopropyl alcohol, bleach/sodium hypochlorite<sup>1</sup> (see important note below), hydrogen peroxide, ammonium chloride, or mild dish soap.



**IMPORTANT:** Use pre-moistened wipes and do not allow liquid cleaner to pool.

Due to the powerful oxidizing nature of sodium hypochlorite, the metal surfaces on the device are prone to oxidation (corrosion) when exposed to this chemical in the liquid form (including wipes). In the event that these type of disinfectants come in contact with metal on the device, prompt removal with an alcohol-dampened cloth or cotton swab after the cleaning step is critical.

### Harmful Ingredients

The following chemicals are known to damage the plastics on the device and should not come in contact with the device: acetone; ketones; ethers; aromatic and chlorinated hydrocarbons; aqueous or alcoholic alkaline solutions; ethanolamine; toluene; trichloroethylene; benzene; carbolic acid and TB-lysoform.

Many vinyl gloves contain phthalate additives, which are often not recommended for medical use and are known to be harmful to the housing of the device.

### Device Cleaning Instructions

Do not apply liquid directly to the device. Dampen a soft cloth or use pre-moistened wipes. Do not wrap the device in the cloth or wipe, instead gently wipe the unit. Be careful not to let liquid pool around the display window or other places. Before use, allow the unit to air dry.



**NOTE:** For thorough cleaning, it is recommended to first remove all accessory attachments, such as hand straps or cradle cups from the mobile device and to clean them separately.

### Special Cleaning Notes

Do not handle the device while wearing vinyl gloves containing phthalates. Remove vinyl gloves and wash hands to eliminate any residue left from the gloves.

If products containing any of the harmful ingredients listed above are used prior to handling the device, such as a hand sanitizer that contains ethanolamine, hands must be completely dry before handling the device to prevent damage to the device.



**IMPORTANT:** If the battery connectors are exposed to cleaning agents, thoroughly wipe off as much of the chemical as possible and clean with an alcohol wipe. It is also recommended to install the battery in the terminal prior to cleaning and disinfecting the device to help minimize buildup on the connectors. When using cleaning/disinfectant agents on the device, it is important to follow the directions prescribed by the cleaning/disinfectant agent manufacturer.

<sup>1</sup> When using sodium hypochlorite (bleach) based products, always follow the manufacturer's recommended instructions: use gloves during application and remove the residue afterwards with a damp alcohol cloth or a cotton swab to avoid prolonged skin contact while handling the device.

### Cleaning Materials Required

- Alcohol wipes
- Lens tissue
- Cotton-tipped applicators
- Isopropyl alcohol
- Can of compressed air with a tube.

### Cleaning Frequency

The cleaning frequency is at the customer's discretion due to the varied environments in which the mobile devices are used and may be cleaned as frequently as required. When dirt is visible, it is recommended to clean the mobile device to avoid the build-up of particles, which makes the device more difficult to clean later on.

For consistency and optimum image capture, it is recommended to clean the camera window periodically especially when used in environments prone to dirt or dust.

### Cleaning the Device

This section describes how to clean the housing, display, and camera for the device.

#### Housing

Thoroughly wipe the housing, including all buttons and triggers, using an approved alcohol wipe.

#### Display

The display can be wiped down with an approved alcohol wipe, but care should be taken not to allow any pooling of liquid around the edges of the display. Immediately dry the display with a soft, non-abrasive cloth to prevent streaking.

#### Camera and Exit Window

Wipe the camera and exit window periodically with lens tissue or other material suitable for cleaning optical material such as eyeglasses.

### Cleaning Battery Connectors

1. Remove the main battery from the mobile computer.
2. Dip the cotton portion of the cotton-tipped applicator in isopropyl alcohol.
3. To remove any grease or dirt, rub the cotton portion of the cotton-tipped applicator back-and-forth across the connectors on the battery and terminal sides. Do not leave any cotton residue on the connectors.
4. Repeat at least three times.
5. Use a dry cotton-tipped applicator and repeat steps 3 and 4. Do not leave any cotton residue on the connectors.

6. Inspect the area for any grease or dirt and repeat the cleaning process if necessary.



**CAUTION:** After cleaning the battery connectors with bleach-based chemicals, follow the Battery Connector Cleaning instructions to remove bleach from the connectors.

### Cleaning Cradle Connectors

1. Remove the DC power cable from the cradle.
2. Dip the cotton portion of the cotton-tipped applicator in isopropyl alcohol.
3. Rub the cotton portion of the cotton-tipped applicator along the pins of the connector. Slowly move the applicator back-and-forth from one side of the connector to the other. Do not leave any cotton residue on the connector.
4. All sides of the connector should also be rubbed with the cotton-tipped applicator.
5. Remove any lint left by the cotton-tipped applicator.
6. If grease and other dirt can be found on other areas of the cradle, use a lint-free cloth and alcohol to remove.
7. Allow at least 10 to 30 minutes (depending on ambient temperature and humidity) for the alcohol to air dry before applying power to cradle.

If the temperature is low and humidity is high, longer drying time is required. Warm temperature and low humidity requires less drying time.



**CAUTION:** After cleaning the cradle connectors with bleach-based chemicals, follow the Cleaning Cradle Connectors instructions to remove bleach from the connectors.

## Troubleshooting

Troubleshooting the device and charging accessories.

### Troubleshooting the Device

The following tables provides typical problems that might arise and the solution for correcting the problem.


**Table 30** Troubleshooting the TC72/TC77

Problem	Cause	Solution
When pressing the power button the device does not turn on.	Battery not charged.	Charge or replace the battery in the device.
	Battery not installed properly.	Install the battery properly.
	System crash.	Perform a reset.
When pressing the power button the device does not turn on but two LEDs blink.	Battery charge is at a level where data is maintained but battery should be re-charged.	Charge or replace the battery in the device.
Battery did not charge.	Battery failed.	Replace battery. If the device still does not operate, perform a reset.

**Table 30** Troubleshooting the TC72/TC77 (Continued)

Problem	Cause	Solution
	Device removed from cradle while battery was charging.	Insert device in cradle. The 4,620 mAh battery fully charges in less than five hours at room temperature.
	Extreme battery temperature.	Battery does not charge if ambient temperature is below 0°C (32°F) or above 40°C (104°F).
Cannot see characters on display.	Device not powered on.	Press the <b>Power</b> button.
During data communication with a host computer, no data transmitted, or transmitted data was incomplete.	Device removed from cradle or disconnected from host computer during communication.	Replace the device in the cradle, or reattach the communication cable and re-transmit.
	Incorrect cable configuration.	See the system administrator.
	Communication software was incorrectly installed or configured.	Perform setup.
During data communication over Wi-Fi, no data transmitted, or transmitted data was incomplete.	Wi-Fi radio is not on.	Turn on the Wi-Fi radio.
	You moved out of range of an access point.	Move closer to an access point.
During data communication over WAN, no data transmitted, or transmitted data was incomplete.	You are in an area of poor cellular service.	Move into an area that has better service.
	APN is not set up correctly.	See system administrator for APN setup information.
	SIM card not installed properly.	Remove and re-install the SIM card.
	Data plan not activated.	Contact your service provider and ensure that your data plan is enable.
During data communication over Bluetooth, no data transmitted, or transmitted data was incomplete.	Bluetooth radio is not on.	Turn on the Bluetooth radio.
	You moved out of range of another Bluetooth device.	Move within 10 meters (32.8 feet) of the other device.
No sound.	Volume setting is low or turned off.	Adjust the volume.
Device shuts off.	Device is inactive.	The display turns off after a period of inactivity. Set this period to 15 seconds, 30 seconds, 1, 2, 5, 10 or 30 minutes.
	Battery is depleted.	Replace the battery.

**Table 30** Troubleshooting the TC72/TC77 (Continued)

Problem	Cause	Solution
Tapping the window buttons or icons does not activate the corresponding feature.	The device is not responding.	Reset the device.
A message appears stating that the device memory is full.	Too many files stored on the device.	Delete unused memos and records. If necessary, save these records on the host computer (or use an SD card for additional memory).
	Too many applications installed on the device.	Remove user-installed applications on the device to recover memory. Select  > <b>Storage</b> > <b>FREE UP SPACE</b> > <b>REVIEW RECENT ITEMS</b> . Select the unused program(s) and tap <b>FREE UP</b> .
The device does not decode with reading bar code.	Scanning application is not loaded.	Load a scanning application on the device or enable DataWedge. See the system administrator.
	Unreadable bar code.	Ensure the symbol is not defaced.
	Distance between exit window and bar code is incorrect.	Place the device within proper scanning range.
	Device is not programmed for the bar code.	Program the device to accept the type of bar code being scanned. Refer to the EMDK or DataWedge application.
	Device is not programmed to generate a beep.	If the device does not beep on a good decode, set the application to generate a beep on good decode.
	Battery is low.	If the scanner stops emitting a laser beam upon a trigger press, check the battery level. When the battery is low, the scanner shuts off before the device low battery condition notification. Note: If the scanner is still not reading symbols, contact the distributor or the Global Customer Support Center.
Device cannot find any Bluetooth devices nearby.	Too far from other Bluetooth devices.	Move closer to the other Bluetooth device(s), within a range of 10 meters (32.8 feet).
	The Bluetooth device(s) nearby are not turned on.	Turn on the Bluetooth device(s) to find.
	The Bluetooth device(s) are not in discoverable mode.	Set the Bluetooth device(s) to discoverable mode. If needed, refer to the device's user documentation for help.
Cannot unlock device.	User enters incorrect password.	If the user enters an incorrect password eight times, the user is requested to enter a code before trying again. If the user forgot the password, contact system administrator.





## Troubleshooting the 2-Slot Charge Only Cradle

**Table 31** Troubleshooting the 2-Slot Charge only Cradle

Symptom	Possible Cause	Action
LEDs do not light when device or spare battery is inserted.	Cradle is not receiving power.	Ensure the power cable is connected securely to both the cradle and to AC power.
	Device is not seated firmly in the cradle.	Remove and re-insert the device into the cradle, ensuring it is firmly seated.
	Spare battery is not seated firmly in the cradle.	Remove and re-insert the spare battery into the charging slot, ensuring it is firmly seated.
Device battery is not charging.	Device was removed from cradle or cradle was unplugged from AC power too soon.	Ensure cradle is receiving power. Ensure device is seated correctly. Confirm main battery is charging. The 4,620 mAh battery fully charges in less than five hours.
	Battery is faulty.	Verify that other batteries charge properly. If so, replace the faulty battery.
	The device is not fully seated in the cradle.	Remove and re-insert the device into the cradle, ensuring it is firmly seated.
	Extreme battery temperature.	Battery does not charge if ambient temperature is below 0 °C (32 °F) or above 40 °C (104 °F).
Spare battery is not charging.	Battery not fully seated in charging slot.	Remove and re-insert the spare battery in the cradle, ensuring it is firmly seated. The 4,620 mAh battery fully charges in less than five hours.
	Battery inserted incorrectly.	Re-insert the battery so the charging contacts on the battery align with the contacts on the cradle.
	Battery is faulty.	Verify that other batteries charge properly. If so, replace the faulty battery.

## Troubleshooting the 2-Slot USB/Ethernet Cradle

**Table 32** Troubleshooting the 2-Slot USB/Ethernet Cradle


Symptom	Possible Cause	Action
During communication, no data transmits, or transmitted data was incomplete.	Device removed from cradle during communications.	Replace device in cradle and retransmit.
	Incorrect cable configuration.	Ensure that the correct cable configuration.
	Device has no active connection.	An icon is visible in the status bar if a connection is currently active.
	USB/Ethernet module switch is not in the correct position.	For Ethernet communication, slide the switch to the  position. For USB communication, slide the switch to the  position.

**Table 32** Troubleshooting the 2-Slot USB/Ethernet Cradle (Continued)

Symptom	Possible Cause	Action
LEDs do not light when device or spare battery is inserted.	Cradle is not receiving power.	Ensure the power cable is connected securely to both the cradle and to AC power.
	Device is not seated firmly in the cradle.	Remove and re-insert the device into the cradle, ensuring it is firmly seated.
	Spare battery is not seated firmly in the cradle.	Remove and re-insert the spare battery into the charging slot, ensuring it is firmly seated.
Device battery is not charging.	Device was removed from cradle or cradle was unplugged from AC power too soon.	Ensure cradle is receiving power. Ensure device is seated correctly. Confirm main battery is charging. The 4,620 mAh battery fully charges in less than five hours.
	Battery is faulty.	Verify that other batteries charge properly. If so, replace the faulty battery.
	The device is not fully seated in the cradle.	Remove and re-insert the device into the cradle, ensuring it is firmly seated.
	Extreme battery temperature.	Battery does not charge if ambient temperature is below 0 °C (32 °F) or above 40 °C (104 °F).
Spare battery is not charging.	Battery not fully seated in charging slot.	Remove and re-insert the spare battery in the cradle, ensuring it is firmly seated. The 4,620 mAh battery fully charges in less than five hours.
	Battery inserted incorrectly.	Re-insert the battery so the charging contacts on the battery align with the contacts on the cradle.
	Battery is faulty.	Verify that other batteries charge properly. If so, replace the faulty battery.


### Troubleshooting the 5-Slot Charge Only Cradle

**Table 33** Troubleshooting the 5-Slot Charge Only Cradle

Problem	Cause	Solution
Battery is not charging.	Device removed from the cradle too soon.	Replace the device in the cradle. The battery fully charges in approximately five hours.
	Battery is faulty.	Verify that other batteries charge properly. If so, replace the faulty battery.
	Device is not inserted correctly in the cradle.	Remove the device and reinsert it correctly. Verify charging is active. Touch  > <b>System</b> > <b>About phone</b> > <b>Battery Information</b> to view battery status.
	Ambient temperature of the cradle is too warm.	Move the cradle to an area where the ambient temperature is between -10 °C (+14 °F) and +60 °C (+140 °F).

## Troubleshooting the 5-Slot Ethernet Cradle

**Table 34** Troubleshooting the 5-Slot Ethernet Cradle

Problem	Cause	Solution
During communication, no data transmits, or transmitted data was incomplete.	Device removed from cradle during communications.	Replace device in cradle and retransmit.
	Incorrect cable configuration.	Ensure that the correct cable configuration.
	Device has no active connection.	An icon is visible in the status bar if a connection is currently active.
Battery is not charging.	Device removed from the cradle too soon.	Replace the device in the cradle. The battery fully charges in approximately five hours.
	Battery is faulty.	Verify that other batteries charge properly. If so, replace the faulty battery.
	Device is not inserted correctly in the cradle.	Remove the device and reinsert it correctly. Verify charging is active. Touch  > <b>System</b> > <b>About phone</b> > <b>Battery Information</b> to view battery status.
	Ambient temperature of the cradle is too warm.	Move the cradle to an area where the ambient temperature is between -10 °C (+14 °F) and +60 °C (+140 °F).

## Troubleshooting the 4-Slot Battery Charger

**Table 35** Troubleshooting the 4-Slot Battery Charger

Problem	Cause	Solution
Spare Battery Charging LED does not light when spare battery is inserted.	Spare battery is not correctly seated.	Remove and re-insert the spare battery into the charging slot, ensuring it is correctly seated.
Spare Battery not charging.	Charger is not receiving power.	Ensure the power cable is connected securely to both the charger and to AC power.
	Spare battery is not correctly seated.	Remove and re-insert the battery into the battery adapter, ensuring it is correctly seated.
	Battery adapter is not seated properly.	Remove and re-insert the battery adapter into the charger, ensuring it is correctly seated.

**Table 35** Troubleshooting the 4-Slot Battery Charger (Continued)

Problem	Cause	Solution
	Battery was removed from the charger or charger was unplugged from AC power too soon.	Ensure charger is receiving power. Ensure the spare battery is seated correctly. If a battery is fully depleted, it can take up to five hours to fully recharge a Standard Battery and it can take up to eight hours to fully recharge an Extended Life Battery.
	Battery is faulty.	Verify that other batteries charge properly. If so, replace the faulty battery.

# Technical Specifications

For device technical specifications, go to [zebra.com/support](http://zebra.com/support).

## Data Capture Supported Symbologies

Item	Description
1D Bar Codes	Code 128, EAN-8, EAN-13, GS1 DataBar Expanded, GS1 128, GS1 DataBar Coupon, UPCA, Interleaved 2 of 5, UPC Coupon Codesymbologies
2D Bar Codes	PDF-417, QR Code, Digimarc, Dotcode

## SE4750-SR Decode Distances

The table below lists the typical distances for selected bar code densities. The minimum element width (or “symbol density”) is the width in mils of the narrowest element (bar or space) in the symbol.

Symbol Density/ Bar Code Type	Typical Working Ranges	
	Near	Far
3 mil Code 39	10.41 cm (4.1 in.)	12.45 cm (4.9 in.)
5.0 mil Code 128	8.89 cm (3.5 in.)	17.27 cm (6.8 in.)
5 mil PDF417	11.18 cm (4.4 in.)	16.00 cm (6.3 in.)
6.67 mil PDF417	8.13 cm (3.2 in.)	20.57 cm (8.1 in.)
10 mil Data Matrix	8.38 cm (3.3 in.)	21.59 cm (8.5 in.)
100% UPCA	5.08 cm (2.0 in.)	45.72 cm (18.0 in.)
15 mil Code 128	6.06 cm (2.6 in.)	50.29 cm (19.8 in.)
20 mil Code 39	4.57 cm (1.8 in.)	68.58 cm (27.0 in.)
Note: Photographic quality bar code at 18° tilt pitch angle under 30 fcd ambient illumination.		

## SE4750-MR Decode Distances

The table below lists the typical distances for selected bar code densities. The minimum element width (or “symbol density”) is the width in mils of the narrowest element (bar or space) in the symbol.

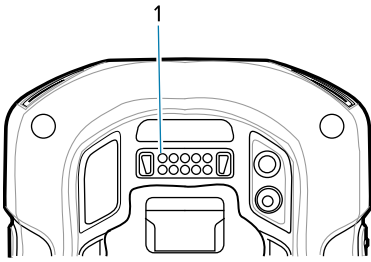
Symbol Density/ Bar Code Type	Typical Working Ranges	
	Near	Far
5 mil Code 128	18.8 cm (7.4 in.)	40.6 cm (16.0 in.)
5 mil PDF417	20.6 cm (8.1 in.)	33.3 cm (13.1 in.)
7.5 mil Data Matrix	21.1 cm (8.3 in.)	32.5 cm (12.8 in.)
10 mil Data Matrix	17.8 cm (7.0 in.)	43.2 cm (17.0 in.)
13 mil UPCA	5.8* cm (2.3* in.)	96.5 cm (38.0 in.)
15 mil Code 128	10.2* cm (4.0* in.)	101.6 cm (40.0 in.)
20 mil Code 39	5.3* cm (2.1* in.)	137.2 cm (54.0 in.)
100 mil Code 39	27.9 cm (11.0 in.)	436.9 cm (172.0 in.)
160 mil Data Matrix	29.2 cm (11.5 in.)	350.5 cm (138.0 in.)
Note: <ul style="list-style-type: none"> <li>* Limited by width of bar code in field of view</li> <li>Photographic quality bar code at 18° tilt pitch angle under 30 fcd ambient illumination.</li> </ul>		

## SE4770 Decode Distances

The table below lists the typical distances for selected bar code densities. The minimum element width (or “symbol density”) is the width in mils of the narrowest element (bar or space) in the symbol.

Symbol Density/ Bar Code Type	Typical Working Ranges	
	Near	Far
3 mil Code 39	3.0 in. (7.9 cm)	5.8 in. (14.7 cm)
5.0 mil Code 128	2.3 in. (8.89 cm)	9.8 in. (24.9 cm)
5 mil PDF417	3.0 in. (7.6 cm)	7.9 in. (20 cm)
6.67 mil PDF417	2.5 in. (6.35 cm)	10.1 in. (26 cm)
10 mil Data Matrix	2.1 in. (5.3 cm)	11.0 in. (28 cm)
100% UPCA	1.6 in. (4.0 cm)	24.9 in. (63.2 cm)
15 mil Code 128	2.4 in. (6.0 cm)	27.8 in. (70.6 cm)
20 mil Code 39	1.6 in. (4.0 cm)	36.1 in. (91.7 cm)
Note: Photographic quality bar code at 18° tilt pitch angle under 30 fcd ambient illumination.		

## I/O Connector Pin-Outs



Pin	Signal	Description
1	GND	Power/signal ground.
2	RXD_MIC	UART RXD + Headset microphone.
3	PWR_IN_CON	External 5.4 VDC power input.
4	TRIG_PTT	Trigger or PTT input.
5	GND	Power/signal ground.
6	USB-OTG_ID	USB OTG ID pin.
7	TXD_EAR	UART TXD, Headset ear.
8	USB_OTG_VBUS	USB VBUS
9	USB_OTG_DP	USB DP
10	USB_OTG_DM	USB DM

## 2-Slot Charge Only Cradle Technical Specifications

Item	Description
Dimensions	Height: 10.6 cm (4.17 in.) Width: 19.56 cm (7.70 in.) Depth: 13.25 cm (5.22 in.)
Weight	748 g (26.4 oz.)
Input Voltage	12 VDC
Power Consumption	30 watts
Operating Temperature	0 °C to 50 °C (32 °F to 122 °F)
Storage Temperature	-40 °C to 70 °C (-40 °F to 158 °F)
Charging Temperature	0 °C to 40 °C (32 °F to 104 °F)
Humidity	5% to 95% non-condensing
Drop	76.2 cm (30.0 in.) drops to vinyl tiled concrete at room temperature.
Electrostatic Discharge (ESD)	+/- 20kV air +/- 10 kV contact +/- 10 kV indirect discharge

## 2-Slot USB/Ethernet Cradle Technical Specifications

Item	Description
Dimensions	Height: 20 cm (7.87 in.) Width: 19.56 cm (7.70 in.) Depth: 13.25 cm (5.22 in.)
Weight	870 g (30.7 oz.)
Input Voltage	12 VDC
Power Consumption	30 watts
Operating Temperature	0 °C to 50 °C (32 °F to 122 °F)
Storage Temperature	-40 °C to 70 °C (-40 °F to 158 °F)
Charging Temperature	0 °C to 40 °C (32 °F to 104 °F)
Humidity	5% to 95% non-condensing
Drop	76.2 cm (30.0 in.) drops to vinyl tiled concrete at room temperature.
Electrostatic Discharge (ESD)	+/- 20kV air +/- 10kV contact +/- 10kV indirect discharge

## 5-Slot Charge Only Cradle Technical Specifications

Item	Description
Dimensions	Height: 90.1 mm (3.5 in.) Width: 449.6 mm (17.7 in.) Depth: 120.3 mm (4.7 in.)
Weight	1.31 kg (2.89 lbs.)
Input Voltage	12 VDC
Power Consumption	65 watts 90 watts with 4-Slot Battery Charger installed.
Operating Temperature	0 °C to 50 °C (32 °F to 122 °F)
Storage Temperature	-40 °C to 70 °C (-40 °F to 158 °F)
Charging Temperature	0 °C to 40 °C (32 °F to 104 °F)
Humidity	0% to 95% non-condensing
Drop	76.2 cm (30.0 in.) drops to vinyl tiled concrete at room temperature.
Electrostatic Discharge (ESD)	+/- 20kV air +/- 10kV contact +/- 10kV indirect discharge



## 5-Slot Ethernet Cradle Technical Specifications

Item	Description
Dimensions	Height: 21.7 cm (8.54 in.) Width: 48.9 cm (19.25 in.) Depth: 13.2 cm (5.20 in.)
Weight	2.25 kg (4.96 lbs)
Input Voltage	12 VDC
Power Consumption	65 watts 90 watts with 4-Slot Battery Charger installed.
Operating Temperature	0 °C to 50 °C (32 °F to 122 °F)
Storage Temperature	-40 °C to 70 °C (-40 °F to 158 °F)
Charging Temperature	0 °C to 40 °C (32 °F to 104 °F)
Humidity	5% to 95% non-condensing
Drop	76.2 cm (30.0 in.) drops to vinyl tiled concrete at room temperature.
Electrostatic Discharge (ESD)	+/- 20kV air +/- 10kV contact +/- 10kV indirect discharge

## 4-Slot Battery Charger Technical Specifications

Item	Description
Dimensions	Height: 4.32 cm (1.7 in.) Width: 20.96 cm (8.5 in.) Depth: 15.24 cm (6.0 in.)
Weight	386 g (13.6 oz.)
Input Voltage	12 VDC
Power Consumption	40 watts
Operating Temperature	0 °C to 40 °C (32 °F to 104 °F)
Storage Temperature	-40 °C to 70 °C (-40 °F to 158 °F)
Charging Temperature	0 °C to 40 °C (32 °F to 104 °F)
Humidity	5% to 95% non-condensing
Drop	76.2 cm (30.0 in.) drops to vinyl tiled concrete at room temperature.
Electrostatic Discharge (ESD)	+/- 20kV air +/- 10kV contact +/- 10kV indirect discharge

## Charge Only Vehicle Cradle Technical Specifications

Item	Description
Dimensions	Height: 12.3 cm (4.84 in.) Width: 11.0 cm (4.33 in.) Depth: 8.85 cm (3.48 in.)
Weight	320 g (11.3 oz.)
Input Voltage	12/24 VDC
Power Consumption	40 watts
Operating Temperature	-40 °C to 85 °C (-40 °F to 185 °F)
Storage Temperature	-40 °C to 85 °C (-40 °F to 185 °F)
Charging Temperature	0 °C to 40 °C (32 °F to 104 °F)
Humidity	5% to 95% non-condensing
Drop	76.2 cm (30.0 in.) drops to vinyl tiled concrete at room temperature.
Electrostatic Discharge (ESD)	+/- 20kV air +/- 10kV contact

## Trigger Handle Technical Specifications

Item	Description
Dimensions	Height: 11.2 cm (4.41 in.) Width: 6.03 cm (2.37 in.) Depth: 13.4 cm (5.28 in.)
Weight	110 g (3.8 oz.)
Operating Temperature	-20 °C to 50 °C (-4 °F to 122 °F)
Storage Temperature	-40 °C to 70 °C (-40 °F to 158 °F)
Humidity	10% to 95% non-condensing
Drop	1.8 m (6 feet) drops to concrete over temperature range.
Electrostatic Discharge (ESD)	+/- 20kV air +/- 10kV contact

## Charging Cable Cup Technical Specifications

Item	Description
Length	25.4 cm (10.0 in.)
Input Voltage	5.4 VDC
Operating Temperature	-20 °C to 50 °C (-4 °F to 122 °F)
Storage Temperature	-40 °C to 70 °C (-40 °F to 158 °F)

## Technical Specifications

Item	Description
Humidity	10% to 95% non-condensing
Electrostatic Discharge (ESD)	+/- 20kV air +/- 10kV contact

### Snap-On USB Cable Technical Specifications

Item	Description
Length	1.5 cm (60.0 in.)
Input Voltage	5.4 VDC (external power supply)
Operating Temperature	-20 °C to 50 °C (-4 °F to 122 °F)
Storage Temperature	-40 °C to 70 °C (-40 °F to 158 °F)
Humidity	10% to 95% non-condensing
Electrostatic Discharge (ESD)	+/- 20kV air +/- 10kV contact

### DEX Cable Technical Specifications

Item	Description
Length	1.5 cm (60.0 in.)
Operating Temperature	-20 °C to 50 °C (-4 °F to 122 °F)
Storage Temperature	-40 °C to 70 °C (-40 °F to 158 °F)
Humidity	10% to 95% non-condensing
Electrostatic Discharge (ESD)	+/- 20kV air +/- 10kV contact

